

**LIGHT  
UP  
YOUR  
LIFE**

SINCE 1942

**MASSMI +MI**

**34**

**REED**

+MI  
MASSMI.COM

**IN MEMORIAM 4**  
**MANUFACTURERS FABRICANTES 6**  
**DESIGNERS DISEÑADORES 8**  
**ALPHABETICAL ALFABÉTICO 12**  
**SUSPENSION LAMPS LÁMPARAS DE SUSPENSIÓN 14**  
**FLOOR LAMPS LÁMPARAS DE PIE 16**  
**TABLE LAMPS LÁMPARAS DE MESA 18**  
**CEILING LAMPS PLAFONES 20**  
**WALL LAMPS LÁMPARAS DE PARED 21**  
**COLLECTIONS COLECCIONES 24**  
**CELINGS FANS VENTILADORES 246**  
**COMBINATIONS COMBINACIONES 250**  
**BULBS BOMBILLAS 254**  
**SCROLLINGS DESPLAZAMIENTOS 255**  
**GENERAL SPECIFICATIONS CARACTERÍSTICAS GENERALES 256**  
**FINISHES ACABADOS 258**



**IN MEMORIAM** Jose Aranda Almiñana

GRACIAS, por tu legado a Massmi (DOT, GRACE, ESTIU Y ZESTA) y por ser de esas personas que vale la pena conocer, y que cuando entras en tu vida, ya no las olvidas nunca.

Cuánto te echo de menos laboralmente, y sobre todo, personalmente!

AMUNT

Héctor Massoni

Tu grandiosa imaginación generosa no ha guiado en la elaboración de esta re-edición del catálogo n°34. Por ti. Por ese compañero de viaje atento, trabajador y creativo, al que siempre consideraré mi mitad perfecta.

Paula Aloy.

MANUFACTURES FABRICANTES



For 82 years Massmi has lighted and decorated thousands of homes with warm and elegant designs. The company was founded in 1942 by Andrés Massoni Sans and managed for more than 50 years by his son Andrés Massoni Muedra, now is managed by the grandsons, Héctor Massoni Gómez in Production and Marketing and Marisa Massoni Gómez in Import-Export and Management. Massmi is expanding its horizons quickly, new collaborations with designers, new showrooms in Latvia and Estonia, new dealers in Poland and Slovakia and participation in some of the most important Exhibitions in Milan, Frankfurt, Moscow or Valencia. The style of the collections is exclusive and contemporary, pieces which are born of love for well done work. Massmi is proud to produce lighting fixtures made in Spain in Valencia factory, objects with soul which define the personality of our house.

Desde hace 82 años Massmi ha iluminado y decorado con diseños cálidos y elegantes miles de hogares. La empresa fundada en 1942 por Andrés Massoni Sans y gestionada durante más de 50 años por su hijo Andrés Massoni Muedra, hoy la dirigen los nietos del fundador, Héctor Massoni Gómez; Producción y Marketing y Marisa Massoni Gómez; Comercio exterior y Administración. Massmi continúa ampliando sus horizontes a un ritmo rápido, nuevas colaboraciones con diseñadores y estudios de arquitectura e interiorismo, nuevas exposiciones en Letonia y Estonia , nuevas distribuciones en Polonia y Eslovaquia, así como participación en las principales ferias del sector como Milán, Frankfurt, Moscú o Valencia. El estilo de las colecciones es exclusivo, contemporáneo y de cuidada factura. Piezas concebidas desde la creencia de que el diseño y la producción son una cuestión de amor por el trabajo bien hecho. Massmi se enorgullece de producir luminarias "made in Spain" desde su fábrica de Valencia, objetos con alma que definen la personalidad de nuestra casa.

**ARANDA ALOY ENBLANC**

The products Dot, Zesta, Grace and Estiu have been designed by José Aranda and Paula Aloy from Enblanc Studio, specialized in Industrial Design, Graphic Communication and Design of spaces. In their projects, the development and sharing of the three specialties gives a global vision to projects in which they always look for practical, simple and coherent solutions for their clients. Since 2011, they have collaborated with CEU Cardenal Herrera University as teachers in the Master in Product Design and the Master in Interior Design. His projects have been exhibited in multiple exhibitions and galleries in Valencia, Barcelona, Madrid, Milan, Finland, Tokyo and among his awards stand out the ADCV '09 Bronze, Accésit Injuve Award '09 or the Nude-Bancaja Scholarship Award. In February 2011, they were the winners of the logo design contest and slogan of the XX Anniversary Pull & Bear.

Los productos Dot, Zesta, Grace y Estiu de Massmi han sido diseñados por José Aranda y Paula Aloy del estudio Aranda Aloy Enblanc, especializado en el ámbito del Diseño Industrial, la Comunicación Gráfica y el Diseño de Espacios. En sus proyectos el desarrollo y puesta en común de las tres especialidades ofrece una visión global, con soluciones prácticas, sencillas y coherentes. Desde 2011 compatibilizaron su actividad profesional con la docencia en la Universidad CEU Cardenal Herrera en el Grado en Ingeniería de Diseño Industrial y Desarrollo de producto, el Master en Diseño de Producto y el Master en Diseño de Interiores.

Sus proyectos han sido expuestos en múltiples exposiciones y galerías de Valencia, Castellón, Barcelona, Madrid, Milán, Finlandia, Tokio y entre sus premios destacan el ADCV '22 de Plata en la categoría de iluminación decorativa concedido a la lámpara Zesta de Massmi, ADCV '09 de Bronce, Premio Accésit Injuve '09 o el premio Beca Nude-Bancaja. En febrero de 2011, fueron los ganadores del concurso de diseño del logotipo y slogan del XX Aniversario Pull&Bear.

**XIMO ROCA**

His professional trajectory began in 1981 but the Ximo Roca Diseño Studio was created in 1989. His work always begin with an immersion in the business reality of the Customer and the understanding of his target market. His projects, national and international, which include industrial and graphic design, interiorism and architecture, have received different prizes and awards. Ximo Roca is surely a versatile and original designer. During more than 30 years he has created products that are today very diffused in the market.

Aunque su trayectoria profesional se inició en 1981, fue en 1989 cuando se creó el estudio Ximo Roca Diseño. Su trabajo se caracteriza por una inmersión inicial en la realidad empresarial de los clientes y por entender el mercado al que ellos se dirigen. Sus proyectos, tanto de ámbito nacional como internacional, abarcan desde el diseño industrial, el diseño gráfico, el interiorismo y la arquitectura y han recibido numerosos premios y galardones. Ximo Roca, es sin duda un diseñador versátil y original. Durante sus más de 30 años de trabajo ha creado numerosos productos que hoy están ampliamente difundidos en el mercado.

**MARTÍN AZÚA**

Martín Azúa is a Basque designer who has worked in Barcelona since 1994. He combines his professional activity as a designer of objects and spaces for important companies with his more creative, speculative work. He belongs to a class of designers who consider experimental methods to be a fundamental part of the design process. Among his best known projects are the "Basic House," which has formed part of the permanent collection of the MOMA in New York since 2007, and the prize medals for the World Swimming Championships held in Barcelona in 2003. He is particularly interested in the incorporation of natural processes into everyday life and the use of artisanal craftsmanship to preserve cultural and technological diversity.

Martín Azúa es un diseñador vasco que trabaja en Barcelona desde el año 1994. Compagina su actividad profesional como diseñador de objetos y espacios para importantes empresas con un trabajo más especulativo. Perteneció a una categoría de diseñadores que considera los métodos experimentales como parte fundamental del proceso de diseño. Entre sus proyectos más conocidos están la "Casa Básica" que desde el 2007 forma parte de la colección permanente del MOMA de New York, las medallas de los campeonatos del mundo de Natación Barcelona 2003. Se siente particularmente interesado por la incorporación de los procesos naturales en la vida cotidiana y la utilización de recursos artesanales para salvaguardar la diversidad cultural y tecnológica.



### NACHO TIMÓN

Nacho Timón is a young and restless spirit designer born in Valencia in 1978. Clear lover of the reason between form and function, always looking for functional beauty, the balance between the concept and the limit of the material to be used. Simple but ingenious concepts, with a touch of humor and irony define their style. Savings in parts and materials, ecology and energy efficiency are some of its objectives. Although in his studio they deal with any assignment, he specializes in lighting design where he collaborates with many of the companies in the sector. He has obtained different recognitions in his still short career: Gold Award ADCV Iluminación 2015 Gold Award in the Advertising Festival La Lluna 2014. Selected in the NUDE 2011 and 2017 and Valencia Prize Creates Product Design 2003.

Nacho Timón es un diseñador de espíritu joven e inquieto nacido en Valencia en 1978. Claro amante del raciocinio entre forma y función, siempre buscando la belleza funcional, el equilibrio entre el concepto y el límite del material a utilizar. Conceptos simples pero ingeniosos, con cierto toque de humor e ironía definen su estilo. El ahorro en piezas y materiales, la ecología y la eficiencia energética son algunos de sus objetivos. Aunque en su estudio abordan cualquier encargo, está especializado en el diseño de iluminación donde colabora con muchas de las empresas del sector. Ha obtenido diferentes reconocimientos en su todavía corta trayectoria: Premio Oro ADCV Iluminación 2015 Premio Oro en el Festival Publicitario La Lluna 2014. Seleccionado en el salón NUDE 2011 y 2017 y Premio Valencia Crea Diseño de Producto 2003.



### CEROCUADRADO\*

cerocuadrado\* is a studio focused on telling stories through the use of industrial design (with both physical & virtual objects), as well as visual, integrating a wide variety of digital creation disciplines. Our projects try to reflect honesty and freshness, with a minimalist approach in which the prominence of raw materials and shapes stands out, complemented by our own personal way to understand color and light.

cerocuadrado\* es un estudio enfocado en transmitir historias a través del diseño tanto de objetos (tanto físicos como virtuales), como visual, integrando una amplia variedad de disciplinas de creación digital. Nuestros proyectos intentan reflejar honestidad y frescura, con un aire minimalista en el que destaca el protagonismo de las materias primas y las formas, complementadas con un uso muy personal del color y la luz.



### XOP STUDIO

XOP// Design Studio based in Muro de Alcoy, founded by Bianca Gracia and Fausto Pascual. "The passion for design and creativity are our engine". We are a multidisciplinary studio specialized in design of products. Specially committed to nature, noble materials and the functional simplicity. We work pampering all details and giving passion to every project.

XOP// Estudio de diseño con base en Muro de Alcoy fundado por Bianca Gracia y Fausto Pascual "La pasión por el diseño y la creatividad son nuestro motor". Somos un estudio multidisciplinar especializado en el diseño de productos. Especialmente comprometido con la naturaleza, los materiales nobles y la sencillez funcional. Trabajamos mimando el detalle y poniendo la máxima pasión en cada uno de nuestros proyectos.



### FLUZO PROJECT

Fluzo Disseny was created as a collaborative multidisciplinary studio specialised in graphic and industrial design. After more than ten years working in design projects, and observing trends and methods, we realised that an external advise is needed when it comes to starting an industrial project. In Fluzo we offer external consulting to those companies who want to develop their projects: analysis of customer's needs, characteristics of design and economic and productive developing methods. Our experience acquired in prototype ateliers, also through managing productions, has been essential to start major projects. We consider our work as a mixture of multidisciplinary actions in which we put professionals of each field in contact in order to success and get an optimum result.

Fluzo Disseny nace como un estudio colaborativo y multidisciplinar en el ámbito del diseño gráfico e industrial. Tras más de 10 años trabajando en el sector del diseño, y observando las tendencias y metodologías de éste, comprendimos que a la hora de realizar un proyecto industrial se necesita de un asesoramiento externo. Desde Fluzo ofrecemos a las empresas consultorías externas para el desarrollo de sus proyectos: analizamos las necesidades del cliente, características del diseño y metodologías de desarrollo económico y productivo. La experiencia adquirida en talleres de prototipado y en la gestión de producciones ha sido el pilar a la hora de emprender proyectos de gran envergadura. Entendemos nuestro trabajo como un conglomerado de acciones multidisciplinares en las que ponemos en contacto a profesionales de cada campo para conseguir un resultado óptimo.

**IN MEMORIAM** 4  
**MANUFACTURERS FABRICANTES** 6  
**DESIGNERS DISEÑADORES** 8  
**ALPHABETICAL ALFABÉTICO** 12  
**SUSPENSION LAMPS LÁMPARAS DE SUSPENSIÓN** 14  
**FLOOR LAMPS LÁMPARAS DE PIE** 16  
**TABLE LAMPS LÁMPARAS DE MESA** 18  
**CEILING LAMPS PLAFONES** 20  
**WALL LAMPS LÁMPARAS DE PARED** 21  
**COLLECTIONS COLECCIONES** 24  
**CEILING FANS VENTILADORES** 246  
**COMBINATIONS COMBINACIONES** 250  
**BULBS BOMBILLAS** 254  
**SCROLLINGS DESPLAZAMIENTOS** 255  
**GENERAL SPECIFICATIONS CARACTERÍSTICAS GENERALES** 256  
**FINISHES ACABADOS** 258

**A**

**ATHINA** 166  
**AURA** 220

**B**

**BERKA** 202  
**BLAIR** 246  
**BLUR** 180  
**BORROCO** 184  
**BUBLE** 216  
**BULB** 154  
**BULBO** 72

**C**

**CIRCA** 224

**D**

**DLED** 236  
**DOT** 40

**E**

**ECLIPSE** 84  
**ESTIU** 64  
**EXA** 194

**F**

**FUSTA** 170

**G**

**GARLAND** 208  
**GRACE** 60

**H**

**HANG OUT** 114  
**HAT** 190  
**HOLD** 162

**I**

**IN OPAQUE** 102  
**IN TRANSLUCENT** 108  
**INFINITO** 124

**K**

**KANATAN** 158

**L**

**LAFFIE** 146  
**LAMPARELLA** 54  
**LAMUDA** 24  
**LIGHT & PLANT CONTAINER** 32  
**LITE** 198  
**LOB** 68  
**LOULU** 128  
**LLUNA** 136

**M**

**MANHATTAN** 176  
**MINA** 174  
**MÍNIMA** 50  
**MOON** 140

**N**

**NAAF** 234  
**NORDIC** 76

**P**

**PEA** 132  
**PETIT** 230  
**POPPOL** 212  
**PURA** 226

**R**

**RENAUD** 46

**S**

**SIMPLICITY** 238

**V**

**VERSUS** 80  
**VOLUM OPAQUE** 90  
**VOLUM TRANSLUCENT** 98

**Z**

**ZESTA** 118





**AURA** 220



**BERKA** 202

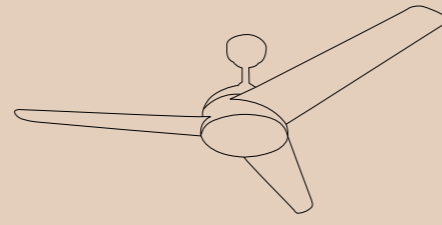

**BLAIR** 246

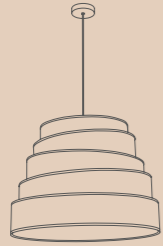

**BLUR** 180



**BORROCO** 184



**BUBLE** 216



**BULB** 154

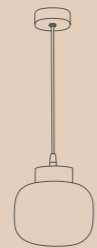

**BULBO** 72



**ESTIU** 64



**EXA** 194

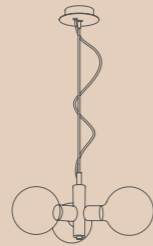

**GARLAND** 208

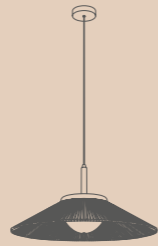

**GRACE** 60



**HAT** 190

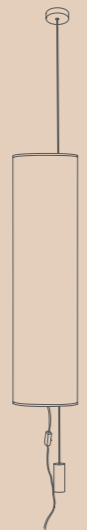

**HANG OUT** 114

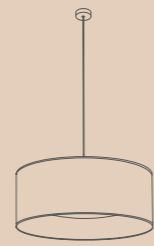

**IN OPAQUE** 102

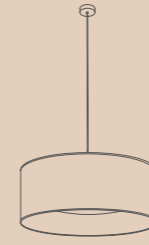

**IN TRANSLUCENT** 108

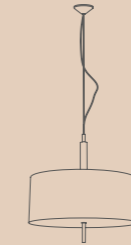

**INFINITO** 124



**KANATAN** 158



**LAFFIE** 146

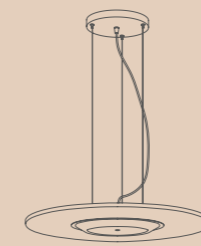

**LAMUDA** 24



**LIGHT & PLANT CONTAINER** 32

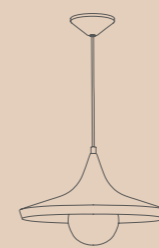

**LITE** 198



**LOB** 68



**LLUNA** 136



**MANHATTAN** 176



**MOON** 140

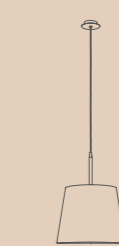

**NAAF** 234



**NORDIC** 76



**PEA** 132

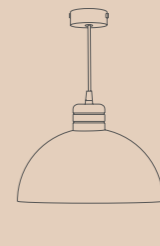

**POPPOL** 212



**RENAUD** 46

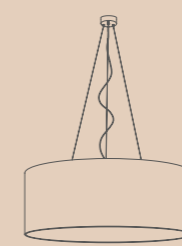

**SIMPLICITY** 238



**VERSUS** 80

SUSPENSION LAMPS LÁMPARAS DE SUSPENSIÓN

SUSPENSION LAMPS LÁMPARAS DE SUSPENSIÓN

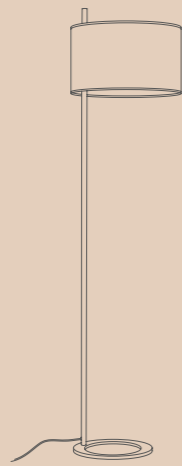

**ATHINA 166**

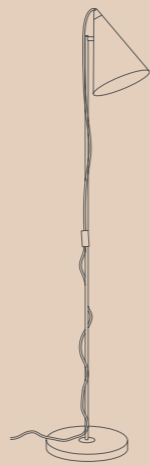

**BERKA 202**

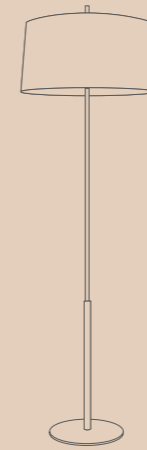

**INFINITO 124**



**KANATAN 158**

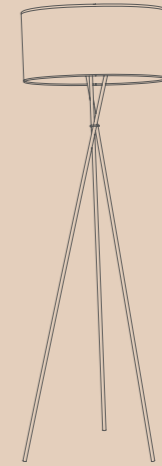

**LOULU 128**



**EXA 194**

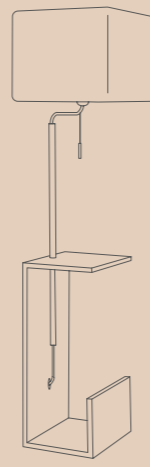

**FUSTA 170**



**MANHATTAN 176**

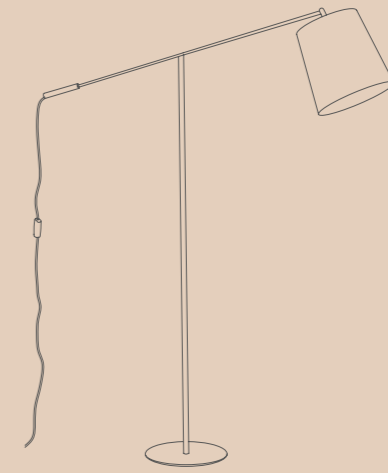

**MINA 174**

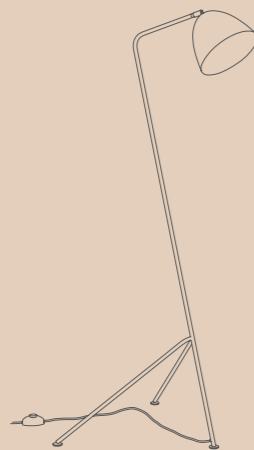

**HAT 190**

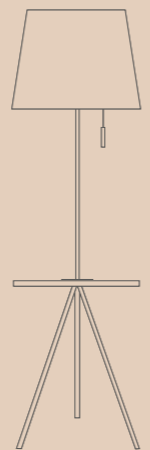

**HOLD 162**



**NAAF 234**



**PETIT 230**

FLOOR LAMPS LÁMPARAS DE PIE

FLOOR LAMPS LÁMPARAS DE PIE

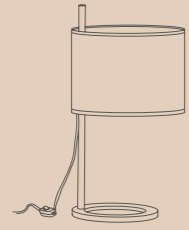

**ATHINA** 166

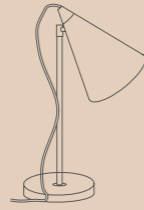

**BERKA** 202



**BORROCO** 184



**LOULU** 128

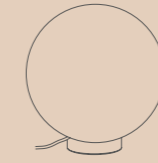

**LLUNA** 136



**MANHATTAN** 176

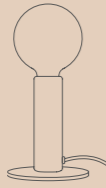

**BULB** 154

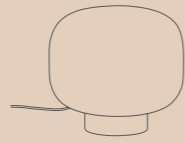

**BULBO** 72



**EXA** 194

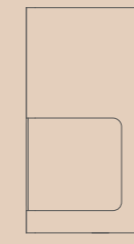

**MÍNIMA** 50



**NAAF** 234

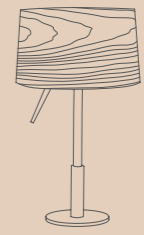

**NORDIC** 76

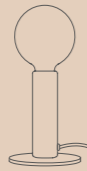

**GARLAND** 208



**HAT** 190



**PEA** 132



**PETIT** 230

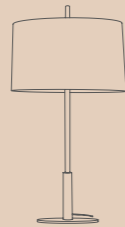

**INFINITO** 124

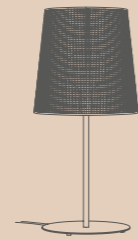

**KANATAN** 158



**SIMPLICITY** 238



**VERSUS** 80

TABLE LAMPS LÁMPARAS DE MESA

TABLE LAMPS LÁMPARAS DE MESA

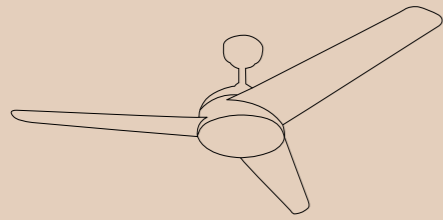

**BLAIR** 246

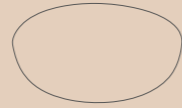

**CIRCA** 224

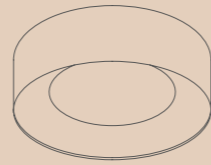

**IN OPAQUE** 102

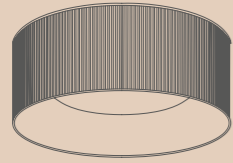

**IN TRANSLUCENT** 108



**LLUNA** 136

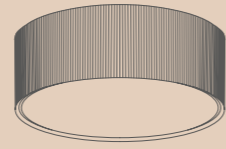

**MANHATTAN** 176

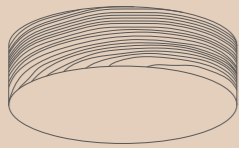

**NORDIC** 76



**PURA** 226

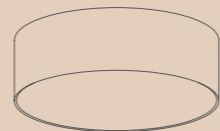

**SIMPLICITY** 238

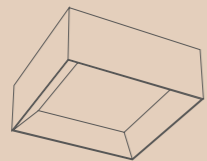

**VOLUM OPAQUE** 90 / **TRANSLUCENT** 98

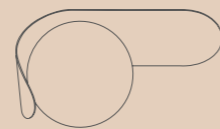
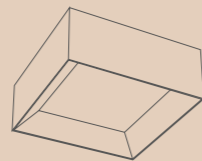

**ZESTA** 118

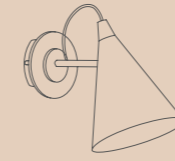

**BERKA** 202



**CIRCA** 224

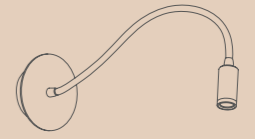

**DLED** 236

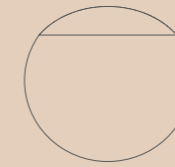

**DOT** 40



**ECLIPSE** 84



**EXA** 194

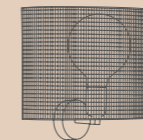

**KANATAN** 158



**LAMPARELLA** 54

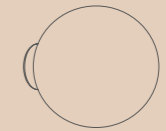

**LLUNA** 136

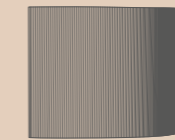

**MANHATTAN** 176

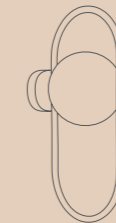

**PEA** 132

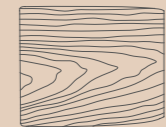

**NORDIC** 76

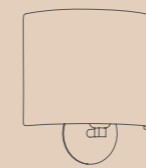

**SIMPLICITY** 238



**ZESTA** 118



# LAMUDA

2019 by Ximo Roca

Lamuda is a sound absorbing lighting, created by using sustainable materials, it helps to solve the uncomfortable problem of the environmental noise.

The Ximo Roca studio gives us the keys for its design: We realized that in spaces especially crowded, as restaurants or offices, we could find bustle and it could be annoying for habitual or sporadic users of this environment. We planned to create something new: a lighting with a double function, to illuminate and at the same time to absorb the sound to make easier any conversation.

Lamuda es una luminaria fonoabsorbente, creada a partir de materiales sostenibles, que ayuda a resolver el incómodo problema del ruido ambiente, favoreciendo el bienestar en los espacios.

El estudio de Ximo Roca destaca las claves de su diseño: Detectamos que, en espacios especialmente concurridos, como pueden ser restaurantes u oficinas, reina el bullicio, algo que puede resultar molesto para las personas que comparten ese entorno ya sea de modo habitual o esporádico. Nos planteamos crear algo nuevo: una lámpara con una doble función, la de iluminar y, al mismo tiempo, absorber el sonido para favorecer una conversación relajada.

Suspension lamp  
Lámpara de suspension  
[Ref 6998 6Q MA](#)  
[Ref 6998 7Q MO](#)



Suspension lamp  
Lámpara de suspensión  
Ref 6998 70 MO





Suspension lamp  
Lámpara de suspensión  
Ref 6998 80 AZ Ref 6998 80 GR

Suspension lamp / Lámpara de suspensión

Ref 6998 80

LED 19W **A+**

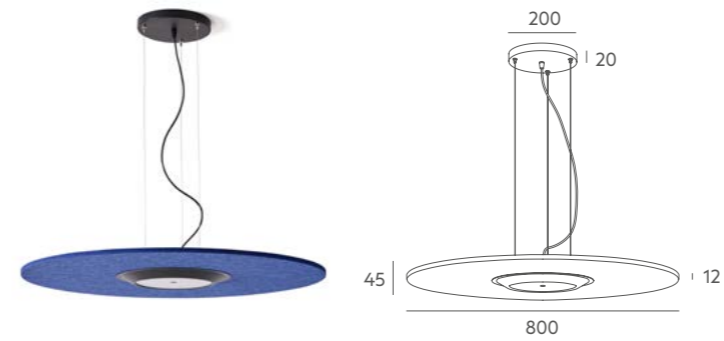

Ref 6998 60

LED 19W **A+**

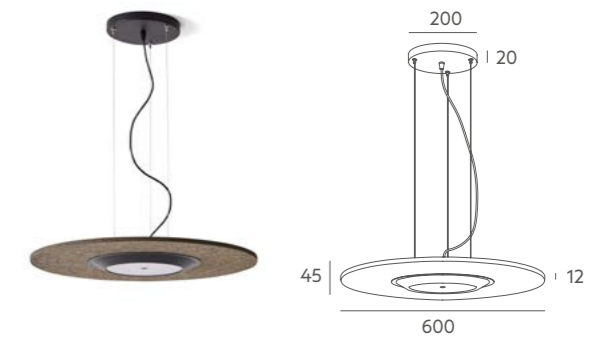

Ref 6998 70

LED 19W **A+**

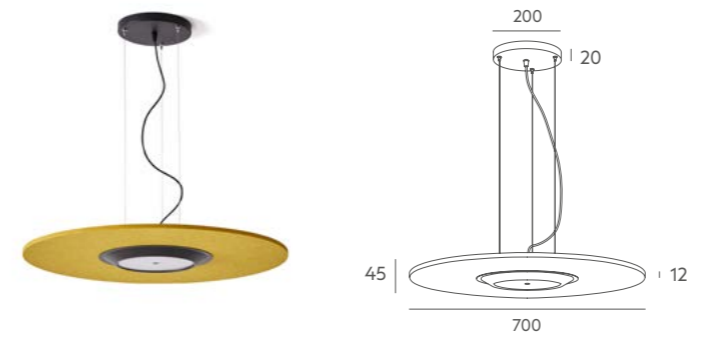

Ref 6998 50

LED 19W **A+**

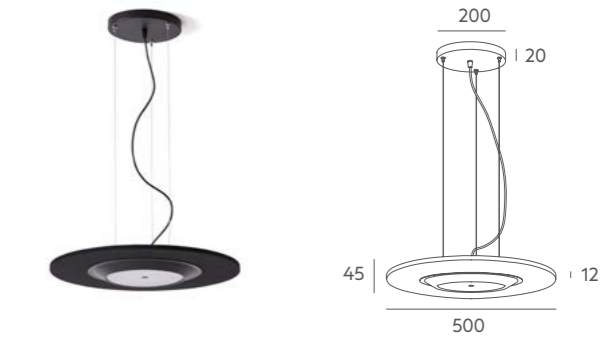

Tecnical data

Frame: black metal.

Details: acoustic PET shade. Opal metacrylate diffuser.  
Steel cable + black PVC cable.

Recommended Bulb: Integral LED module.  
48 LED / Pm= 19W / In= 800mA= 24W - Made in Spain  
3000K o 4000K. 1500lm. (Included).  
Transformer 30W max. 220-240V, 50-60Hz. (Included).

Important: the standard cable length is 1,5 metre, if you need special size please contact our Customer Support Department.

Finishes Acabados

PET Colour / Acabado PET



Methacrylate / Metacrilato



Metal Colour / Acabado Metal



Información técnica

Cuerpo: metal negro.

Detalles: pantalla acústica PET. Difusor de metacrilato opal.  
Cable de acero + cable PVC negro.

Bombilla recomendada: Integral LED module.  
48 LED / Pm= 19W / In= 800mA= 24W - Made in Spain  
3000K o 4000K. 1500lm. (Incluido).  
Transformador 30W máx. 220-240V, 50-60Hz. (Incluido).

Importante: la longitud del cable estándar es de 1,5 metro, si desea una medida especial no dude en ponerse en contacto con nosotros.





Suspension lamp  
Lámpara de suspensión  
Ref 6998 120 AZ

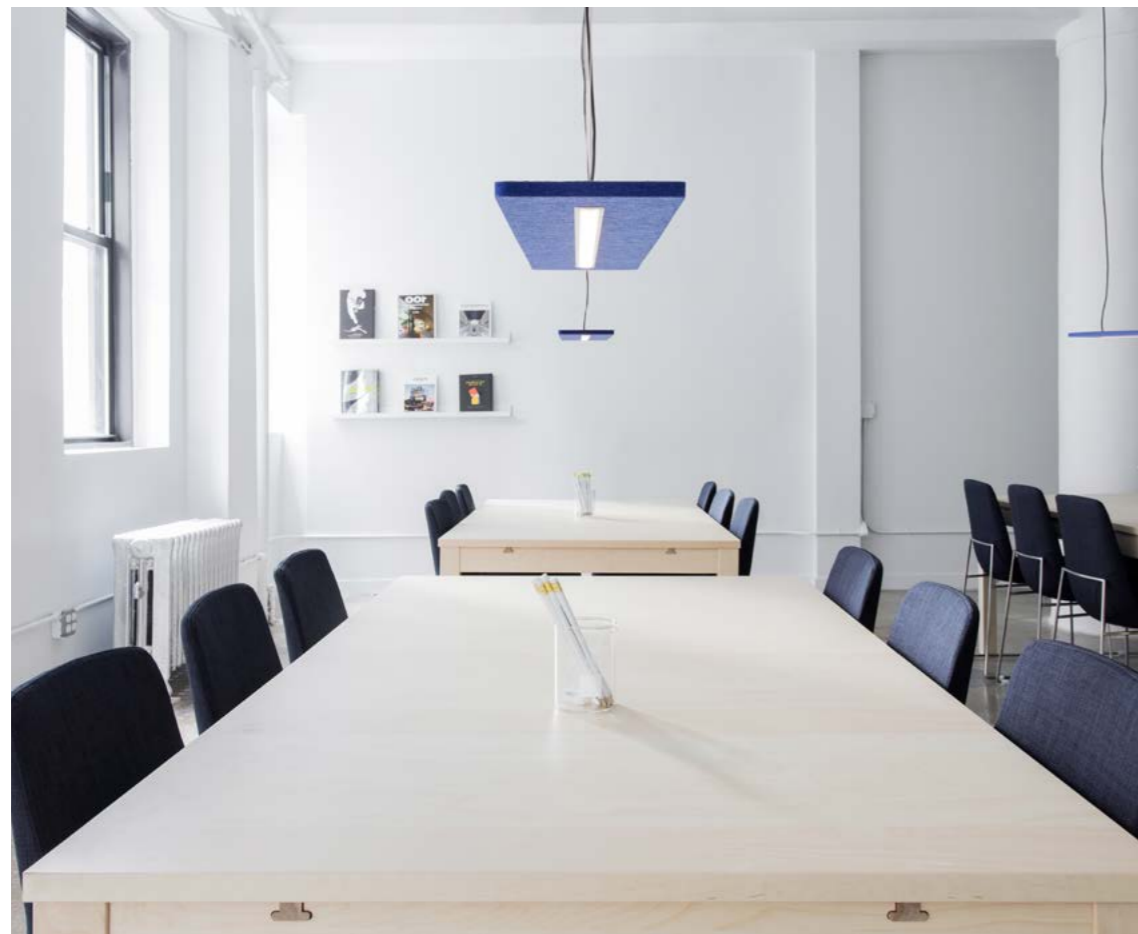

Suspension lamp / Lámpara de suspensión

Ref 6998 120

LED 19W

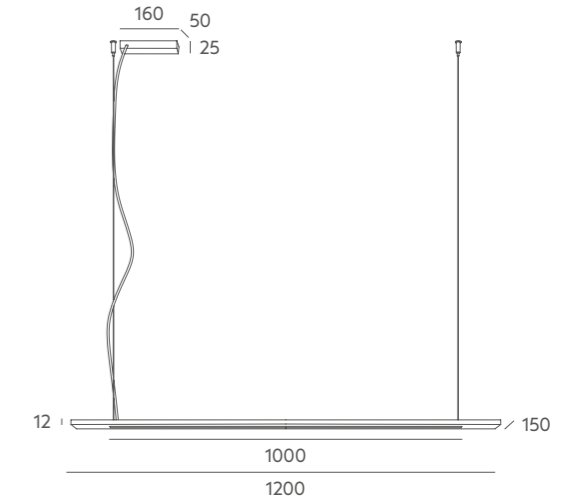
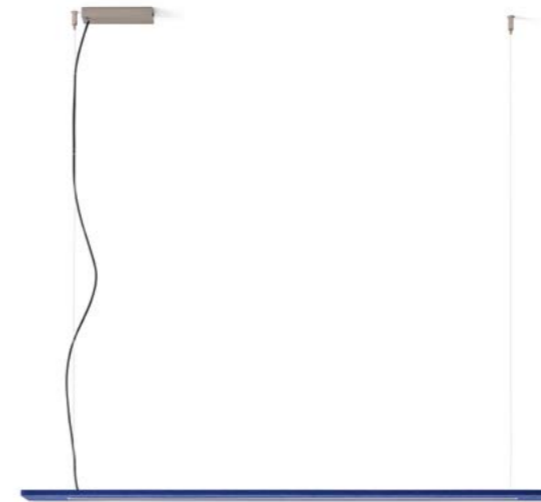

Tecnical data

Frame: satin nickel metal.

Details: acoustic PET shade. Opal metacrylate diffuser. Steel cable + black PVC cable.

Recommended Bulb: 14,4W 3000K o 4000K. 1342Lm LED (included). Transformer 20W máx. 220-240V, 50-60Hz. (Included).

Important: the standard cable length is 1,5 metre, if you need special size please contact our Customer Support Department.

Finishes Acabados

PET Colour / Acabado PET



Methacrylate / Metacrilato



Metal Colour / Acabado Metal



PET ACOUSTIC PANEL

100% polyester PET (60% recycled PET fiber + 40% virgin PET fiber)

Fire Class: ASTM E84 Class A | EN 13501 Class B - S1, D0

Environmental Certificate: OEKO-TEX® STANDARD 100

Acoustic performance: noise reduction coefficient (NRC 0.4) according to ISO 354:2003 in a reverberant room

Weighted sound absorption coefficient (aw 0.25) according to ISO 11654:1997

Free of formaldehyde / No chemical irritants / Composition 60% recycled / 100% recyclable / Free of odors

Easy maintenance: resistant to dirt and dust / Impact resistant / Easy to handle

Thermal insulation / Moisture control / Antifungal properties

Información técnica

Cuerpo: metal níquel satinado.

Detalles: pantalla acústica PET. Difusor de metacrilato opal. Cable de acero + cable PVC negro.

Bombilla recomendada: 14,4W 3000K o 4000K. 1342Lm LED (incluida). Transformador 20W máx. 220-240V, 50-60Hz. (Incluido).

Importante: la longitud del cable estándar es de 1,5 metro, si desea una medida especial no dude en ponerse en contacto con nosotros.

PANEL ACÚSTICO PET

100% poliéster PET (60% fibra PET reciclada + 40% fibra PET virgen)

Clase a prueba de fuego: ASTM E84 Clase A | EN 13501 Clase B - S1, D0

Certificado Medioambiental: OEKO-TEX® STANDARD 100

Rendimiento acústico: coeficiente de reducción de ruido (NRC 0,4) según la norma ISO 354:2003 en una sala reverberante

Coefficiente de absorción acústica ponderado (aw 0,25) según ISO 11654:1997

Libre de formaldehído / Sin irritantes químicos / Composición 60% reciclada / 100% reciclable / Libre de olores

Fácil mantenimiento: resistente a la suciedad y al polvo / Resistente al impacto / Fácil de manejar

Aislamiento térmico / Control de humedad / Propiedades antifúngicas

# LIGHT & PLANT CONTAINER

by **Martín Azúa**

Light emanates from inside a metal basket that seems to float. Light, of course, is immaterial, but at the same time lamps are objects in and of themselves. In this case, light is treated as something that has weight and volume. The lamp is made in two different sizes. The glass diffuser generates a warm, diffuse, and pleasant light with soft shadows, very suitable for tables in restaurants, bars, and reception areas – even on tables in meetings and in the workplace. Its sculptural character helps customize singular spaces, halls, stairwells, and more.

Una masa de luz en el interior de una cesta metálica que parece flotar. La luz es inmaterial, pero al mismo tiempo las lámparas también son un objeto. En este caso tratamos la luz como algo que tiene peso y volumen. Se hace en dos tamaños diferentes. El difusor de vidrio genera una luz cálida, difusa y agradable con sombras suaves, muy indicada para mesas de restaurantes, barras, recepciones, mesas de reuniones y trabajo. Su carácter escultórico permite personalizar espacios singulares halls, huecos de escaleras...

MASSMI + MI



Ceiling Lamp  
Suspensión  
[Ref 6994 G LIGHT NMT](#)  
[Ref 6994 P LIGHT NMT](#)



SINCE 1942

Suspension lamps  
Lámparas de suspensión  
[Ref 6995 G PLANT VE](#)  
[Ref 6994 G LIGHT GA](#)



Ceiling Lamp  
Suspensión  
[Ref 6994 G LIGHT NMT](#)  
[Ref 6994 P LIGHT NMT](#)



Suspension plant container  
Plant container de suspensión  
[Ref 6995 G PLANT BMT](#)



Ceiling Lamp  
Suspensión  
Ref 6994 G LIGHT NMT  
Ref 6994 P LIGHT NMT

Ceiling lamp / Suspensión

Ref 6994 P LIGHT

LED 1 x 7W **A+**

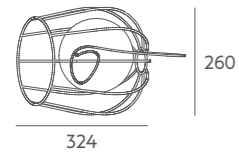
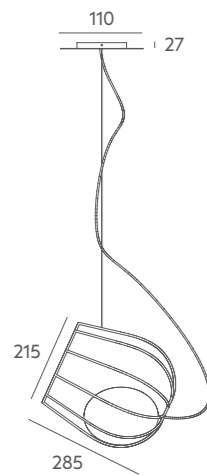

Ref 6994 G LIGHT

LED 1 x 7W **A+**

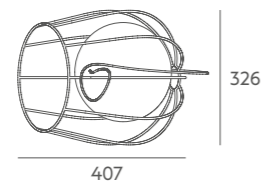
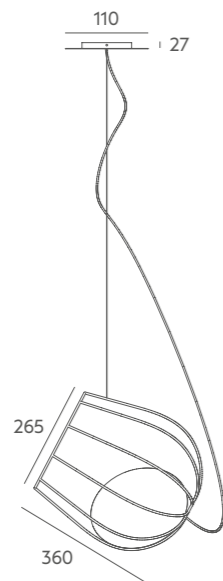

Ref 6995 P PLANT

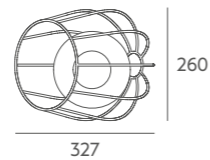
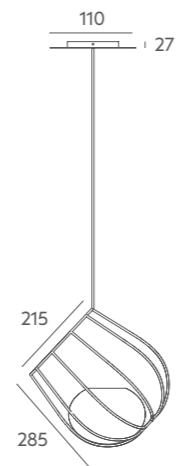

Ref 6995 G PLANT

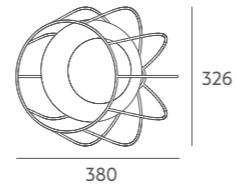
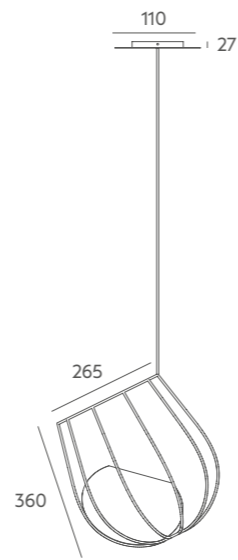

Tecnichal data

Frame: light Container frame painted iron metal. Opal glass diffuser. Plant Container frame painted iron metal.

Details: stoneware pot inside (plant not included). Cotton rope.

Recommended Bulb: E27 7W LED no dimmable 3000k (520lm) (included).

Important: the standard cable length is 1,5 metre, if you need special size please contact our Customer Support Department.

Finishes Acabados

Metal Colour / Acabado Metal



Glass / Cristal



Stoneware / Gres



Información técnica

Cuerpo: Cuerpo Ligh Container: cuerpo metálico de hierro pintado. Difusor de cristal opal. Plant Container cuerpo metálico de hierro pintado.

Detalles: maceta de gres (planta no incluida). Cuerda de algodón

Bombilla recomendada: E27 7W LED no dimmable 3000k (520lm) (incluida).

Importante: la longitud del cable estándar es de 1,5 metro, si desea una medida especial no dude en ponerse en contacto con nosotros.



Ceiling Lamp  
Suspensión  
Ref 6994 G LIGHT GA  
Ref 6995 G PLANT VE  
Ref 6994 P LIGHT VE

# DOT

2015 by Aranda Aloy Enblanc

Dot has been created by making a slight gesture of movement on a basic geometric figure, the circle. This particular gesture marks the difference, allowing the sconce to bathe the wall on which it is installed with the light coming from the angled aperture. It is a versatile, functional, and contemporary piece that can be adapted to multiple applications and combinations in the home, in the workplace, or in public spaces.

DOT surge de la aplicación de un ligero gesto de movimiento sobre una figura geométrica básica, el círculo. Un gesto que marca la diferencia y que permite que a través de esa apertura la luz del aplique bañe con elegancia la pared sobre la que se instala. Es una pieza versátil, funcional y contemporánea que permite múltiples aplicaciones y combinaciones en los proyectos de hábitat, espacio profesional y contract. DOT gives the option to incorporate customized information by using a signage to be adapted to each project or need.



Wall lamp  
Lámpara de pared  
[Ref 1692 P VE](#)  
[Ref 1692 P AZ](#)

Wall lamp  
Lámpara de pared  
[Ref 1692 TG MO](#)  
[Ref 1692 P VE](#)  
[Ref 1692 P AZ](#)





Wall lamp  
Lámpara de pared  
Ref 1692 P VE  
Ref 1692 P BMT



Wall lamp  
Lámpara de pared  
Ref 1692 G GR  
Ref 1692 G BMT  
Ref 1692 P BMT  
Ref 1692 P PE  
Ref 1692 G PE

Wall lamp / Lámpara de pared

Ref 1692 G

LED 1 x G9 4W **A+**

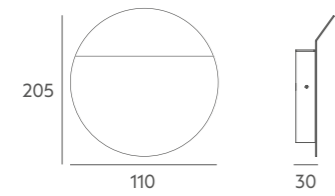

Ref 1692 P

LED 1 x G9 4W **A+**

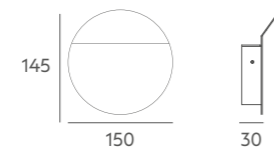

Custom exemple / Ejemplo personalización

**SIGNAL OPTIONS / SEÑALITICA**

Ref 1692 TG

LED 1 x G9 4W **A+**

CUSTOM / PERSONALIZACIÓN

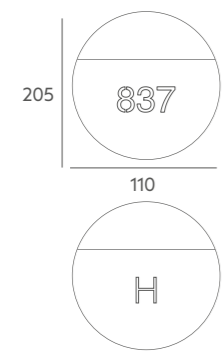

STANDARDIZATION / ESTANDARIZACIÓN



Option to add 2 lights in the die cut product, ask for it.  
Posibilidad de incorporar 2 luces en los troquelados bajo demanda.

**Tecnichal data**

Frame: painted curved iron metal.

Details: difusor de luz de metacrilato.

Recommended Bulb: G9 4W 3000K. 400 Lm 36° LED (included).

Important: can be installed in any position, ceiling and wall. We can evaluate to change painting colour for projects with a minimum quantity of pieces, please check with us.

**Información técnica**

Cuerpo: metal hierro curvado pintado.

Detalles: methacrylated light diffuser.

Bombilla recomendada: G9 4W 3000K. 400 Lm 36° LED (incluida).

Importante: puede colocarse en cualquier posición, tanto a techo como a pared. Se puede valorar cambios de color de pintura para proyectos con un mínimo de unidades, no duden en consultarnos.

**Finishes Acabados**

Metal Colour / Acabado Metal



Methacrylate / Metacrilato

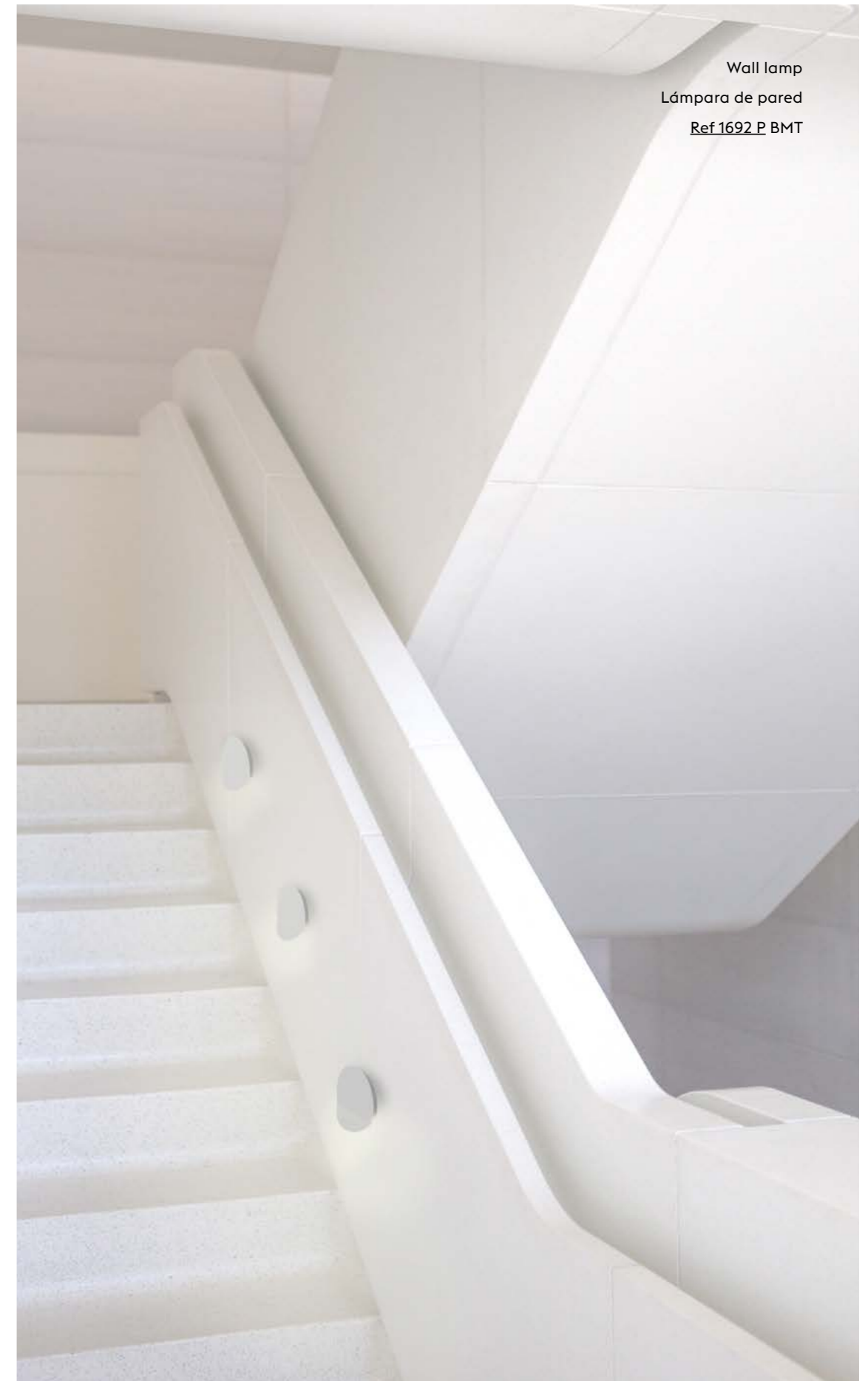

Wall lamp  
Lámpara de pared  
Ref 1692 P BMT



# RENAUD

2015 cerocuadrado\*

Renaud nace como un ejercicio de minimalismo, combinado con un estudio de materiales clásicos del sector que progresivamente han ido perdiendo su presencia. Recuperamos la cerámica, trabajada de forma artesanal, para aplicarla al diseño como componente principal en una forma suave que ayuda a transmitir sobriedad y elegancia. Su brazo de madera torneada le añade un carácter propio, al romper las simetrías de la pieza, sin privarla de una armonía formal. Cada unidad de Renaud nace de la mano de un artesano ceramista que le imprime una a una su personalidad única e irrepetible y que sin embargo encaja elegantemente en cualquier tipo de ambiente. Los contrastes entre tradición y modernidad, la personalidad de la cerámica y la sofisticación de la madera son los que le confieren a este modelo su carácter sobrio y atemporal.

Renaud was born as an exercise in minimalism, combined with a study of classic materials that have gradually disappeared from the lighting industry. In this lamp we have rediscovered hand-made pottery and applied it to the design as the main component, its soft form conveying sobriety and elegance. The arm, made of lathed wood, adds a character all its own, breaking the symmetry of the piece without taking away any of its formal harmony. Each "Renaud" lamp is handmade by a ceramics artisan, who imprints his or her unique personality on each and every piece. These lamps fit in elegantly with any type of atmosphere. The contrasts between tradition and modernity, the personality of pottery and the sophistication of wood, are what give this model its sober and timeless character.

Ceiling lamp  
Suspensión  
[Ref 6990](#)



Ceiling lamp / Suspensión

Ref 6990

GU10 8W LED **A+**

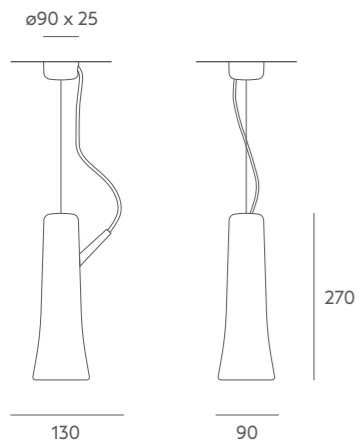

**Tecnical data**

Frame: glazed porcelain.

Details: Oaky wood sticked details. Black PVC wire.

Recommended Bulb: GU10 LED Cob 100° 8W 3000k (700lm) included.

**Finishes Acabados**

Metal Colour / Acabado Metal



Wood / Madera



**Información técnica**

Cuerpo: cerámica esmaltada.

Detalles: madera de haya pegado. Cable negro PVC.

Bombilla recomendada: GU10 LED Cob 100° 8W 3000k (700lm) incluida.



# MÍNIMA

2014 by Nacho Timón

La lámpara de sobremesa Mínima es fruto directo de la crisis económica, se trataba de ofrecer al cliente un modelo sencillo, elegante, contemporáneo... con pocas piezas y sobretodo económico. Después de darle muchas vueltas surgió Mínima, surgió esta sencilla lamparita de sobremesa de aires pop realizada con una única pieza está pensada para situarse junto a paredes o rincones, donde rebotando la luz que emite consigue crear cálidos ambientes. Un pieza de metal de 2 mm de grosor cortado a láser al que se le aplica un pliegue que le da rigidez y carácter. Lista, la definición de menos es más, hecha realidad.

The Mínima table lamp is a direct result of the global economic crisis; it was designed to offer the customer a simple model with elegant, contemporary lines, made with few pieces and, most importantly, available at a reasonable price. After giving these ideas a lot of thought, Mínima emerged, a simple pop-up lamp made in one piece and designed to be placed next to walls or corners, where the reflected light creates a warm, cozy atmosphere. A piece of metal 2 mm thick is first cut with a laser and then enhanced with a special fold that lends the lamp stability and character. And there you have it, the definition of "less is more" come to life.

**D** PREMIO  
ADCV 2015  
ORO



Sobremesa  
Table Lamp  
Ref 4422 GR

Sobremesa / Table Lamp

Ref 4422

G9 4W LED 

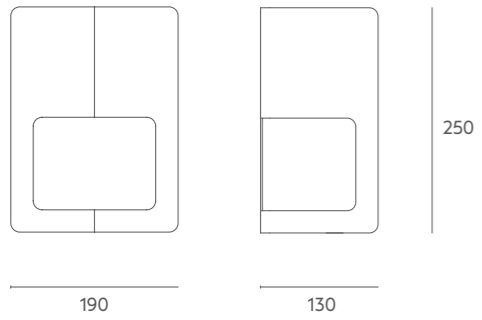

**Tecnical data**

Frame: painted iron metal.

Details: Transparent PVC wire.

Recommended Bulb: G9 4W LED no dimmable 3000k (400lm) included.

**Finishes Acabados**

Metal Colour / Acabado Metal



Cable / Cable

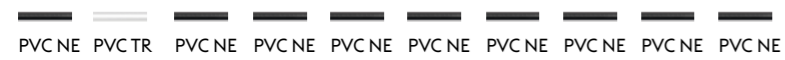

**Información técnica**

Cuerpo: metálico de hierro pintado

Detalles: Cable transparente o negro PVC según modelo.

Bombilla recomendada: G-9 4W LED no dimable 3000K (400lm) incluida.



SINCE 1942

# LAMPARELLA

2014 by Nacho Timón

Lamparella es una lámpara conceptual que respira un marcado estilo contract, surge de la idea de fusionar mesitas de noche y la lamparita que se sitúa encima, de líneas puras y realizada con dos piezas de madera curvada, lacada de colores o no. Este singular modelo permite incorporar en su cuerpo mecanismos, tales como interruptores que permitieran controlar la propia lámpara como otras luces o elementos domóticos de la habitación así como persianas, cortinas ....

Lamparella a concept lamp with a marked mid-century industrial style, arises from the idea of merging a bedside table and lamp. Its pure lines are comprised of two pieces of curved wood that can be lacquered in various colors or left plain. This unique model allows for the incorporation of various mechanisms such as switches that control not only the lamp itself, but also other lights or decorative elements in the room, including blinds, curtains, and more.

MASSMI + MI



Wall lamp  
Aplique  
REF 1688 BL



SINCE 1942

Wall lamp  
Aplique  
REF 1688 GR

Wall lamp / Aplique

Ref 1688

E27 11W LED A+

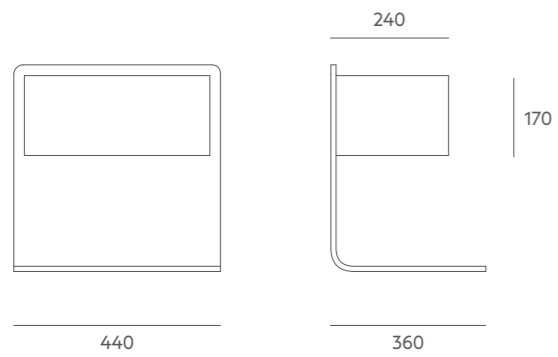

Tecnical data

Frame: plywood  
Details: Up methacrylate light diffuser included.  
Recommended Bulb: E27 11W LED (no included).

Finishes Acabados

Frame plywood / Acabado madera



Información técnica

Cuerpo: madera contrachapada.  
Detalles: Difusor superior de luz de metacrilato incluido.  
Bombilla recomendada: E27 11W LED (no incluida).



Wall lamp  
Aplique  
REF 1688 GR



# GRACE

2020 by Aranda Aloy Enblanc

Grace collection is known by its versatility and the use of the rope that defines its design and creates a complicity with glassshade and wood. It allows visibility and introduce light, so comfortable ambiances are created. Its design reminds the shape of the sunhat "pamela". Available in different sizes and colors, gives possibility to create several combinations.

La colección Grace destaca por su versatilidad y uso de la cuerda, la cual dibuja y define formalmente su diseño, guardando complicidad con la tulipa y la madera permitiendo su visibilidad y da paso a la luz, generando así ambientes cálidos y confortables. Su diseño recuerda a la forma de una pamela. Disponible en varios tamaños, colores y con la posibilidad de la realización de diferentes combinaciones.

MASSMI + MI



Suspension lamp  
Lámpara de suspensión  
[Ref 6015-40 VE HA](#)  
[Ref 6015-40 TE HA](#)  
[Ref 6015-40 MO HA](#)  
[Ref 6015-60 MA HA-NE](#)

SINCE 1942

Suspension lamp  
Lámpara de suspensión  
[Ref 6015-40 VE HA](#)   [Ref 6015-60 MO HA-NE](#)   [Ref 6015-40 TE HA](#)   [Ref 6015-90 VE HA-NE](#)



Ceiling lamp / Suspensión

Ref 6015-90

LED 3 x 7W **A+**

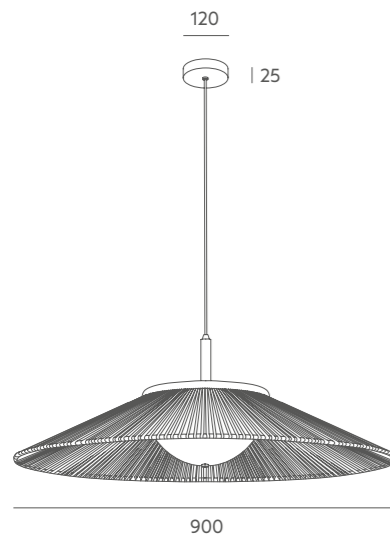

Ref 6015-60

LED 3 x G9 4W **A+**

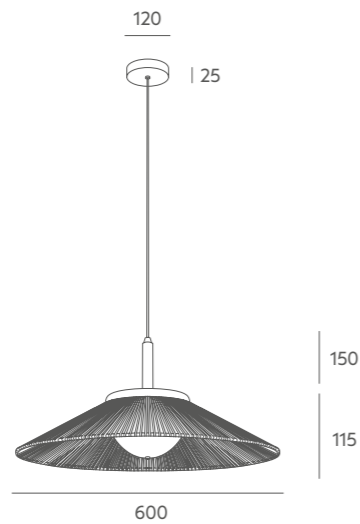

Ref 6015-40

LED 3 x G9 4W **A+**

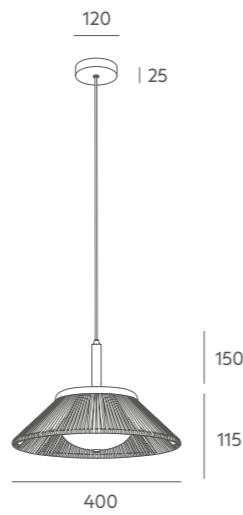

**Tecnical data**

Frame: : braided rope. Varnished beech wood. Black metal canopy.

Details: opal metacrylate diffuser. Black PVC cable.

Recommended Bulb: Ref 6015 - 90 E-27 7W LED (not included). Ref 6015 - 40 - 60 G9 4W 3000K. 400 Lm 36° LED (included).

Important: the standard cable length is 1,5 metre, if you need special size please contact our Customer Support Department.

**Información técnica**

Cuerpo: cuerda trenzada. Madera de haya barnizada. Florón de metal negro.

Detalles: difusor de metacrilato opal. cable PVC negro.

Bombilla recomendada: Ref 6015 - 90 E-27 7W LED (no incluida). Ref 6015 - 40 - 60 G9 4W 3000K. 400 Lm 36° LED (incluida).

Importante: la longitud del cable estándar es de 1,5 metro, si desea una medida especial no dude en ponerse en contacto con nosotros.

**Finishes Acabados**

String Colour / Acabado cuerda



Methacrylate / Metacrilato

Wood / Madera



Metal Colour / Acabado Metal



Suspension lamp  
Lámpara de suspensión  
Ref 6015-90 MA HA

# ESTIU

2020 by Aranda Aloy Enblanc

Estiu combines the rope as technical material with the cotton of two cylindrical shades which seems to be floating on the air. Its light and shape move us to a summer nightfall where lanterns are protagonist. Available in different sizes and colors, allow us to create several combinations.

Estiu combina la técnica de cuerda con el algodón de una pantalla cilíndrica de sujeción interna que parece flotar en el aire. Su luz y forma nos traslada a un anochecer de verano donde los farolillos son los protagonistas. Disponible en varios tamaños, colores y con la posibilidad de la realización de diferentes combinaciones.



Rope color details  
Detalle colores cuerda



Suspension Lamps  
Lámparas de suspensión  
Ref. 6017 MA



Example composition / Ejemplo composición  
**G434-45 + Ref 6016 VE + Ref 6017 VE + Ref 6018 VE**  
 LED 3 x 11W **A+**



more compositions in page 254 / Más composiciones en página 254

Ceiling lamp / Suspensión  
**Ref 6017**  
 LED 1 x 11W **A+**

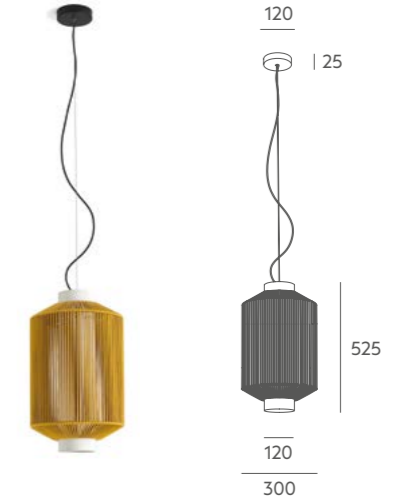

**Ref 6018**  
 LED 1 x 11W **A+**



**Ref 6016**  
 LED 1 x 11W **A+**







**Tecnichal data**

Frame: braided rope. Black metal canopy.  
 Details: translucent beige cotton shade. Steel cable + black PVC cable.  
 Recommended Bulb: E-27 11W LED (not included).  
 Important: the standard cable length is 2 metre, if you need special size please contact our Customer Support Department.

**Información técnica**

Cuerpo: cuerda trenzada. Florón de metal negro.  
 Detalles: pantalla de tela de algodón crema traslúcido. Cable de acero + cable PVC negro.  
 Bombilla recomendada: E-27 11W LED (no incluida).  
 Importante: la longitud del cable estándar es de 2 metros, si desea una medida especial no dude en ponerse en contacto con nosotros.

**Finishes Acabados**

String Colour / Acabado cuerda	Shade / Pantalla	Metal Colour / Acabado Metal
   		
MA MO TE VE	CR	NMT



Suspension lamps  
 Lamparas de suspensión  
**G434-45 + Ref 6016 VE + Ref 6017 VE + Ref 6018 VE**

# LOB

2018 by Fluzo Project

---

It suggests an impossible idea: to catch the light. It has a hanging system made of natural leather including a lighting sphere floating in the space with an elegant aesthetic. LOB gives to its nucleus the complete importance. It's a perfect lighting for home or contract projects as well.

Insinúa una idea imposible: atrapar la luz. Tiene un sistema de sujeción en piel natural que permite incluir una esfera de luz flotando en el espacio con una estética elegante. LOB proporciona a su núcleo toda la importancia. Sus líneas atemporales hacen de esta lámpara un modelo perfecto para espacios domésticos e instalaciones.



MASSMI + MI

SINCE 1942

Ref 6943-30  
Suspension lamp  
Lámpara de suspensión

Suspension lamps / Lámparas de suspensión

Ref 6943-30

LED 1 x 11W **A+**

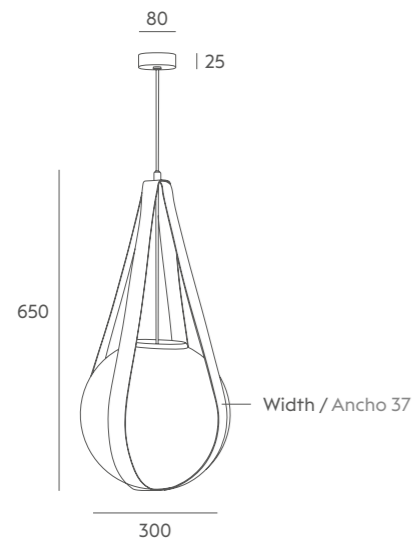

Ref 6943-25

LED 1 x 11W **A+**

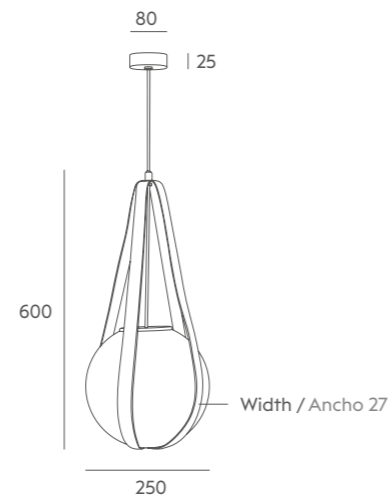

Tecnical data

Frame: satin brass imitation painting. Chocolate leather colour.

Details: opal mate glasses fixed by nuts. Black PVC cable.

Recommended Bulb: E27 11W LED (not included).

Important: standard length of wire is 1 metre, if you need special length please contact us. We can evaluate to change colour of leather for projects with a minimum quantity of pieces, please check with us.

Finishes Acabados

Glass / Cristal



OP-MT

Leather / Piel



MA

Metal Colour / Acabado Metal



D

Información técnica

Cuerpo: metal hierro pintado imitación latón satinado. Piel color chocolate.

Detalles: tulipas opal mate cogida con tornillos. Cable negro PVC.

Bombilla recomendada: E27 11W LED (no incluida).

Importante: la longitud del cable estándar es de 1 metro, si desea una medida especial no dude en ponerse en contacto con nosotros. Se puede valorar cambio de color en la piel para proyectos con un mínimo de unidades, no duden en consultarnos.



Suspension lamp

Lámpara de suspensión

Ref 6943-30



# BULBO

2018 by XOP // Studio

Bulbo it's a lighting collection based on simplicity and timelessness. The design is a commitment to the functional sobriety by using natural materials as the diffuser made of white matte glass and the small wooden base, who balances the natural simplicity of the collection.

Colección de lámparas basada en la sencillez y la atemporalidad. Con este diseño se pretende hacer una apuesta por la sobriedad funcional utilizando materiales nobles, como el difusor diseñado en vidrio blanco matizado y una pequeña base de madera de roble macizo que le confiere carácter además de equilibrar la sencillez natural de la colección.



Suspensión lamps  
Lámparas de suspensión  
[Ref 6012-P](#)   [Ref 6012-G](#)

Table lamp  
Lámparas de mesa  
[Ref 4002-G](#)   [Ref 4002-P](#)



Suspension lamp  
Lámpara de suspensión  
Ref 6012-G

Table lamp  
Lámpara de mesa  
Ref 4002-P

Suspension lamps / Lámparas de suspensión

Ref 6012-G

LED 1 x 11W **A+**



Ref 6012-P

LED 1 x 7W **A+**

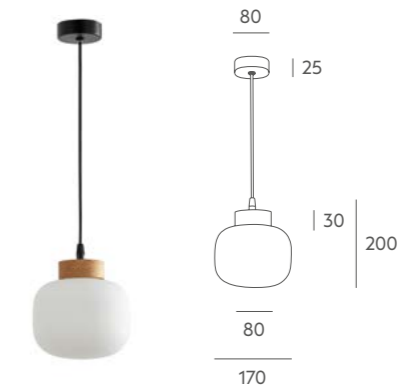
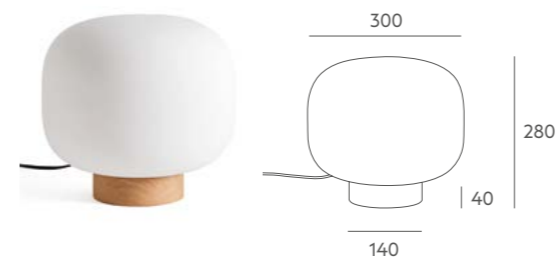

Table lamps / Lámparas de mesa

Ref 4002-G

LED 1 x 11W **A+**



Ref 4002-P

LED 1 x 7W **A+**

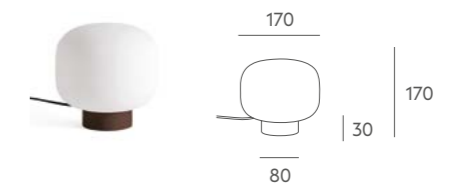

Tecnical data

Frame: : varnished oaky wood. Black metal canopy.  
Details: clip opal mate glasses. Black PVC cable.

Recommended Bulb: big Size E-27 11W LED. Small Size E-27 7W LED (not included).

Important: standard length of cable is 1 metre, if you need special length please contact us. We can evaluate to change colour of wood for projects with a minimum quantity of pieces, please check with us.

Finishes Acabados

Glass / Cristal



Wood / Madera



Metal Colour / Acabado Metal



Información técnica

Cuerpo: madera de roble barnizada. Florón de metal negro.  
Detalles: tulipas opal mate cogida con pinzas. Cable PVC negro.

Bombilla recomendada: tamaño Grande E-27 11W LED. Tamaño pequeño E-27 7W LED (no incluida).

Importante: la longitud del cable estándar es de 1 metro, si se desea una medida especial póngase en contacto con nosotros. Se puede valorar cambio en el color de la madera para proyectos con un mínimo de unidades, no duden en consultarnos.



# NORDIC

2015 by Massmi

Our new version of "Infinito" is a homage to Scandinavian style, which revolutionized the design world with its use of noble materials, especially wood. Made of wood and is available in either natural beech or bleached ash.

Con Nordic hacemos nuestro pequeño homenaje al estilo escandinavo que tanto ha aportado al diseño y la decoración en el empleo de materiales nobles, en particular la madera. La pantalla está realizada en dos tipos de madera a elegir, haya natural y fresno tintado en blanco.

MASSMI +MI



Wall lamp  
Lámpara de pared  
Ref 1504 BL



Ceiling lamps  
Plafones  
Ref 3503-70 BL  
Ref 3503-25 HA  
Ref 3503-50 HA  
Ref 3503-25 BL

Suspension lamp  
Lámpara de suspensión  
Ref 6802 BL

Table lamp  
Lámpara de mesa  
Ref 4432 P BL

Wall lamps  
Lámparas de pared  
Ref 1503 HA  
Ref 1504 HA

SINCE 1942



Suspension lamp / Lámpara de suspensión

Ref 6802

LED 3 x 7W **A+**

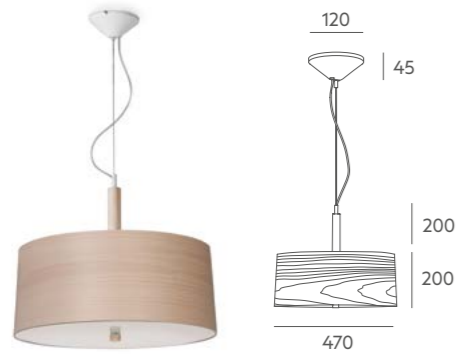
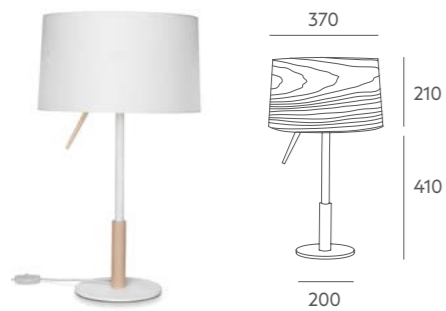

Table lamps / Lámparas de mesa

Ref 4432 G

LED 2 x 7W **A+**



Wall lamps / Lámparas de pared

Ref 1503

LED 1 x 7W **A+**



Ref 1504

LED 1 x 7W **A+**



Ref 4432 P

LED 2 x 7W **A+**



Ceiling lamp / Plafón

Ref 3503

LED Ø 25, 2 x 7W  
LED Ø 50, 2 x 11W  
LED Ø 70, 4 x 11W **A+**

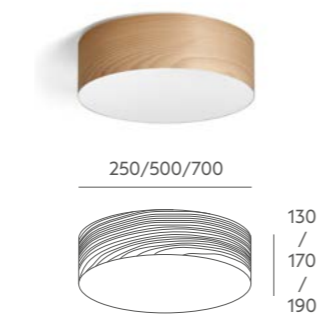

Tecnical data

Frame: matte white or matte black painted iron metal, combined with beech wood.

Details: natural beech wood or white painted ash-tree wood shade. Transparent PVC cable. Beech wood handle and ornament. The pendant has glass diffuser. Opal metacrylate diffuser for ceiling lamps. Table lamp and floor lamp are adjustable by using a knee cap. This collection has a special support. The big table lamp has not diffuser. The small table lamp use a partial disc to cover the sockets. Ceiling lamp with stone sockets and magnet system to hang the shade.

Recommended Bulb: E-27 7W or 11W LED (not included).

Important: standard length of cable is 1 metre, if you need special length please contact us. We can evaluate to change colour of wood for projects with a minimum quantity of pieces, please check with us.

Finishes Acabados

Shade / Pantalla



BL HA

Methacrylate or glass/ Metacrilato o cristal



OP

Metal Colour / Acabado Metal



BMT



Información técnica

Cuerpo: metal hierro pintado en blanco mate texturado combinado con madera de haya.

Detalles: pantalla madera natural de haya o fresno tintado en blanco. Cable transparente PVC. Asa y remate de madera en haya. La lámpara de suspensión lleva difusor de cristal. Plafones difusor metacrilato opal. Los sobremesa son basculantes mediante una rótula. Toda la familia lleva una cogida especial. La lámpara de mesa grande no lleva difusor. La lámpara de mesa pequeña lleva un disco parcial para tapar los portálamparas. Versión plafón, portálamparas de piedra y sistema de sujeción de la pantalla con imanes.

Bombilla recomendada: E-27 7W o 11W LED (no incluida).

Importante: la longitud del cable estándar es de 1 metro, si se desea una medida especial póngase en contacto con nosotros. Se puede valorar cambio en el color de la madera para proyectos con un mínimo de unidades, no duden en consultarnos.



Suspension lamp  
Lámpara de suspensión  
Ref 6802 BL

# VERSUS

2012 by Massmi

Versus was initially designed as a ceiling lamp for spaces that require an extra-large lighting fixture. The handmade shade is made of silk ribbon and comes in five colors. Even when switched off, Versus is an attractive fixture; switched on it emanates a nuanced light.

Inicialmente creamos una lámpara de suspensión pensada para proyectos que requieran dimensiones XXL, así nació Versus. Su pantalla de cinta de seda colocada artesanalmente está disponible en cinco colores. Apagada posee una atractiva presencia y encendida propaga una luz rica en matices.



Silk ribbon shade detail  
Detalle pantalla cinta de seda



Suspension lamp  
Lámpara de suspensión  
Ref 6937- 80 VE

Suspension lamps / Lámparas de suspensión

Ref 6937-80/100

LED 5 x 11W **A+**



Ref 6937-60

LED 3 x 11W **A+**



Table lamp / Lámpara de mesa

Ref 4400

LED 1 x 7W **A+**



Ref 6937-40/50

LED 1 x 11W **A+**



Tecnical data

Frame: painted or coated iron metal.

Details: silk ribbon shade without diffuser. Structure with silk ribbon volume. Special support for pendant lamp shades. Wire according to metal colour. Suspension lamp Ø 400/500/600 textile cable. Table lamp transparent or black PVC cable. For Ø 800 and Ø 1000 pendant, steel cable is used.

Recommended Bulb: E-27 7W or 11W LED (not included).

Important: the standard cable length is 1 metre, if you need special size please contact our Customer Support Department.

Información técnica

Cuerpo: metal hierro pintado o bañado.

Detalles: pantalla seda encintada sin difusor. Estructura con volumen encintada. Cogidas de la pantalla especiales en suspensión. Cable según versión. Lámpara de suspensión Ø 400/500/600 cable textil. Lámpara de mesa cable PVC transparente o negro. Montura de suspensión Ø 800 y Ø 1000 con cable de acero.

Bombilla recomendada: E-27 7W o 11W LED (no incluida).

Importante: la longitud del cable estándar es de 1 metro, si desea una medida especial no dude en ponerse en contacto con nosotros.

Finishes Acabados

Shade / Pantalla



BL CR GR NE VE

Metal Colour / Acabado Metal

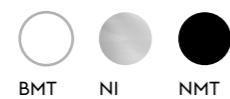

BMT NI NMT

Cable / Cable

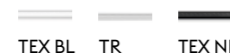

TEX BL TR TEX NE



Table lamp  
Lámpara de mesa  
Ref 4400 NMT GR

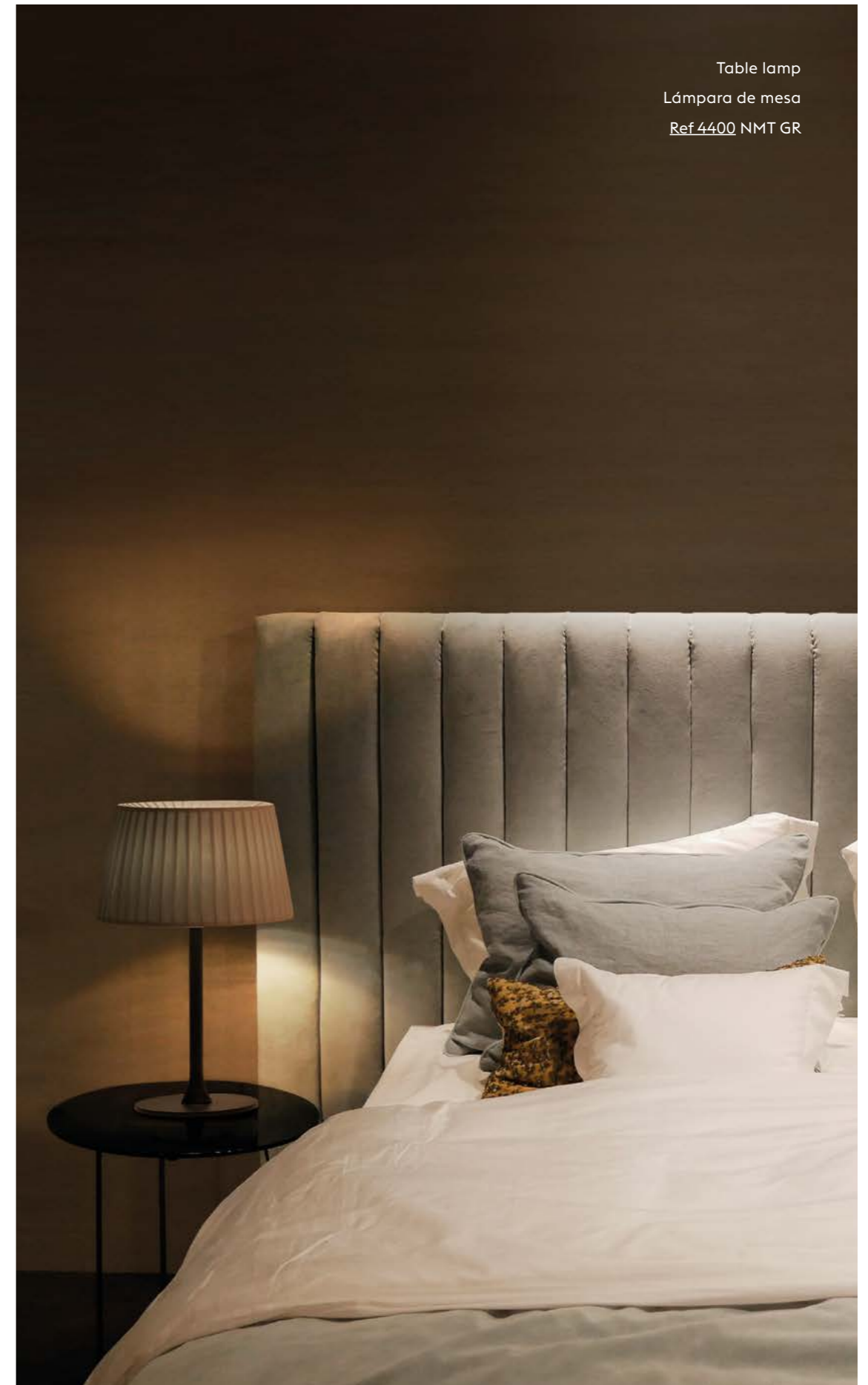

# ECLIPSE

2021 by Massmi

This collection of wall lamps simulates the intersection between light and shape, it reminds us the eclipse phenomenon. Decorative, round shaped, two versions with and without brim, variety of sizes to create wonderful combinations. It is versatile to be used in Contract and private settings, the diffused light obtained make warm and cosy ambiances.

Colección de apliques que simula la intersección de luz y forma, nos recuerda al fenómeno del eclipse. De carácter decorativo con forma circular que gracias a sus dos versiones, con y sin ala y a la variedad de tamaños permite crear maravillosas combinaciones. Su versatilidad hace que este modelo pueda incorporarse tanto en proyectos de ámbito residencial como en proyectos relacionados con el contract. Emite una luz difusa que genera espacios cálidos y acogedores.



Ceiling lamp & wall lamps  
Plafones y lámparas de pared  
Ref 3504-50 BL / AZ  
Ref 3504-70 BL



Ceiling lamp & wall lamps  
Plafones y lámparas de pared  
[Ref 3504-70 BL](#)  
[Ref 3504-50 BL](#)



Ceiling lamp & wall lamps  
Plafones y lámparas de pared  
[Ref 3506-40 BL / AZ](#)  
[Ref 3506-25 BL / AZ](#)



Ceiling lamp & wall lamps  
Plafones y lámparas de pared  
Ref.3504-50 MA

Plafond & wall lamp / Plafón y lámpara de pared

Ref 3504-70

LED 2 x 11W **A+**

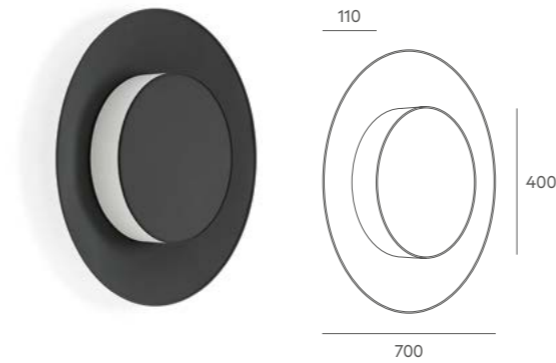

Ref 3504-50

LED 2 x 7W **A+**

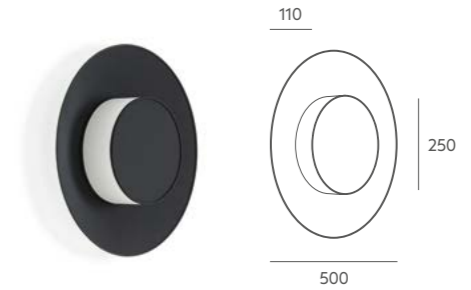

Ref 3506-40

LED 2 x 11W **A+**

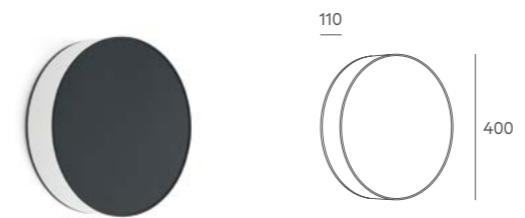

Ref 3506-25

LED 2 x 7W **A+**



**Tecnical data**

Details: opaque cotton lampshade. Side white parchment diffuser. Stone sockets and magnet system to hang the shade.

Recommended bulb: E-27 7W or 11W LED (not included).

Important: we can evaluate to change lampshade material for projects with a minimum quantity of pieces, please check with us.

Shade / Pantalla



**Información técnica**

Detalles: pantalla de tela algodón opaco. Difusor lateral de pergamino blanco. Portalámparas de piedra y sistema de sujeción de la pantalla con imanes.

Bombilla recomendada: E-27 7W o 11W LED (no incluida).

Importante: se puede valorar cambios de tela para proyectos con un mínimo de unidades, no duden en consultarnos.



# VOLUM OPAQUE

2011 by Massmi

Volum is perfect flushmount lamp for home or office. By combining two or more ceiling lamps with its simple magnet system, clients can create their own compositions that go beyond the traditional look these types of lamps traditionally have. Available in black or white opaque cotton and five shapes, one of them with three sizes. The option with gold inside has been incorporated. The combinations are endless and the result is always spectacular.

Volum es una luminaria de techo tanto para el hogar como el Contract que, combinando dos o más plafones y con su sistema imantado, crea una composición que va más allá de las formas tradicionales en este tipo de luminarias. Está disponible en dos colores: algodón opaco blanco o negro y cinco formatos, uno de ellos con tres medidas. Se ha incorporado la opción con el interior dorado. Las combinaciones son infinitas y el resultado, siempre espectacular.

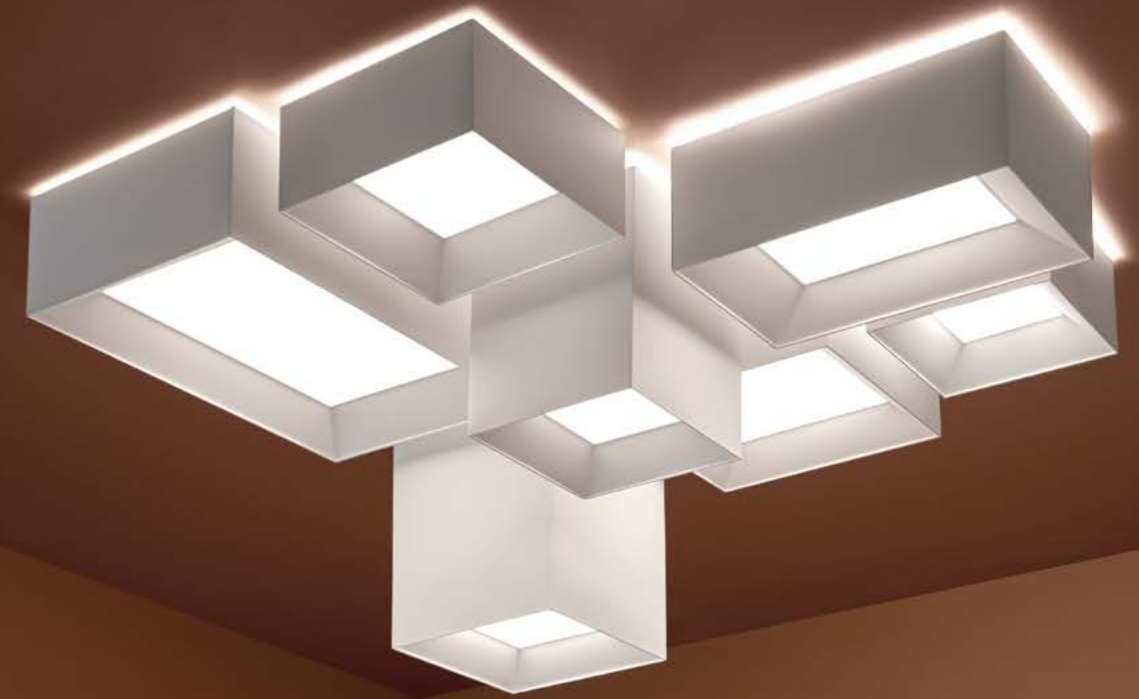

Example composition / Ejemplo composición  
 Ref 3485-35-BL + Ref 3485-40 BL + Ref 3485-50 BL  
 Ref 3498 BL + Ref 3499 BL + Ref 3484 BL + Ref 3483 BL

Example composition / Ejemplo composición  
Ref 3485-40 BL + Ref 3485-50 BL + Ref 3483 BL





A



B



Example composition A / Ejemplo composición A

[Ref 3497-50 NE](#) + [Ref 3500 NE](#) + [Ref 3495 NE](#)

Example composition B / Ejemplo composición B

[Ref 3497-50 BL](#) + [Ref 3501 BL](#) + [Ref 3495 BL](#) + [Ref 3496 BL](#)

Ceiling lamps / Plafones

Ref 3485-35 BL / NE

Ref 3497-35 BL-D / NE-D \*  
\* Golden interior / Interior dorado

LED 2 x 11W **A+**

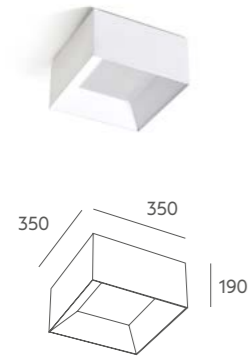

Ref 3485-40 BL / NE

Ref 3497-40 BL-D / NE-D \*  
\* Golden interior / Interior dorado

LED 2 x 11W **A+**

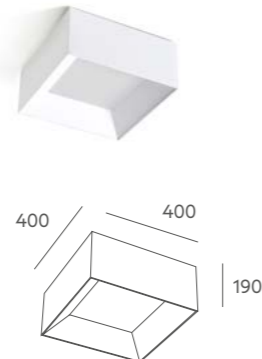

Ref 3485-50 BL / NE

Ref 3497-50 BL-D / NE-D \*  
\* Golden interior / Interior dorado

LED 4 x 11W **A+**

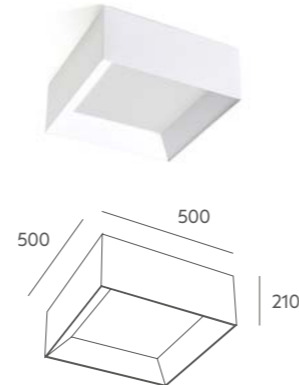

Ref 3484 BL / NE

Ref 3496 BL-D / NE-D \*  
\* Golden interior / Interior dorado

LED 3 x 11W **A+**

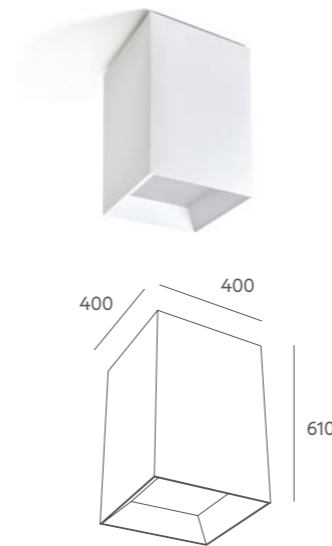

Ref 3483 BL / NE

Ref 3495 BL-D / NE-D \*  
\* Golden interior / Interior dorado

LED 2 x 11W **A+**

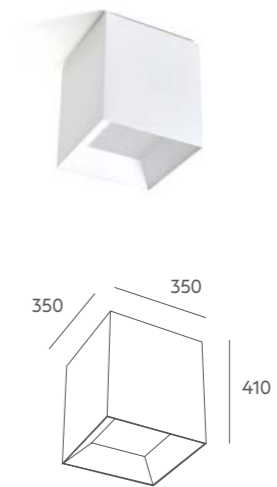

Ref 3498 BL/NE

Ref 3500 BL-D / NE-D \*  
\* Golden interior / Interior dorado

LED 2 x 11W **A+**

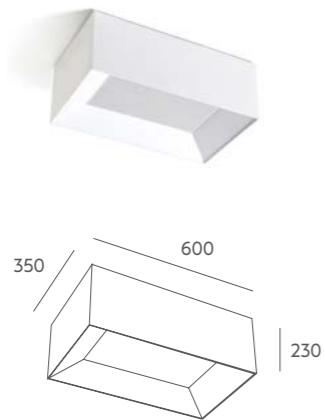

Ref 3499 BL/NE

Ref 3501 BL-D / NE-D \*  
\* Golden interior / Interior dorado

LED 4 x 11W **A+**

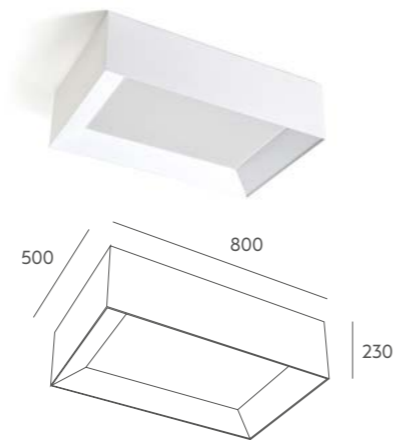

Example composition A / Ejemplo composición A

Ref 3483 + Ref 3484 + Ref 3485-35 BL / NE

Ref 3495 + Ref 3496 + Ref 3497-35 BL-D / NE-D \*  
\* Golden interior / Interior dorado



Example composition B / Ejemplo composición B

Ref 3483 + Ref 3484 + Ref 3485-50 + Ref 3499 BL / NE

Ref 3495 + Ref 3496 + Ref 3497-50 + Ref 3501 BL-D / NE-D \*  
\* Golden interior / Interior dorado

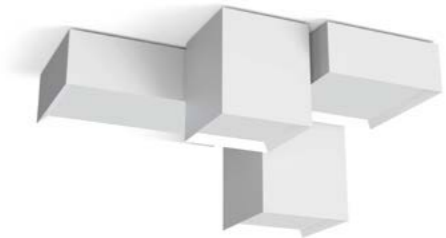

Tecnical data

Details: opaque cotton lampshade. White parchment diffuser. Magnet system.

Recommended bulb: E-27 11W LED (not included).

Important: we can evaluate to change lampshade material for projects with a minimum quantity of pieces, please check with us.

Información técnica

Detalles: pantalla tela algodón opaco. Difusor de pergamino blanco. Sistema de sujeción de la pantalla con imanes.

Bombilla recomendada: E-27 11W LED (no incluida).

Importante: se puede valorar cambios de tela para proyectos con un mínimo de unidades, no duden en consultarnos.

Finishes Acabados

Shade / Pantalla



Example composition C / Ejemplo composición C

Ref 3484 + Ref 3485-50 + Ref 3499 + Ref 3498

+ Ref 3485-40 BL / NE

Ref 3496 + Ref 3497-50 + Ref 3501 + Ref 3500

+ Ref 3497-40 BL-D / NE-D \* \* Golden interior / Interior dorado

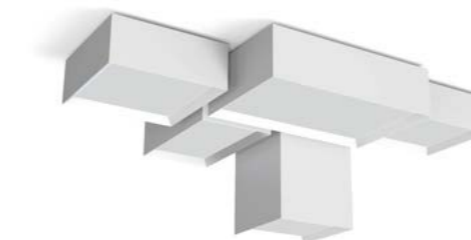

Example composition D / Ejemplo composición D

Ref 3483 + Ref 3484 + Ref 3498 + Ref 3499 + Ref 3485-35

+ Ref 3485-50 BL / NE

Ref 3495 + Ref 3496 + Ref 3500 + Ref 3501 + Ref 3497-35

+ Ref 3497-50 BL-D / NE-D \* \* Golden interior / Interior dorado

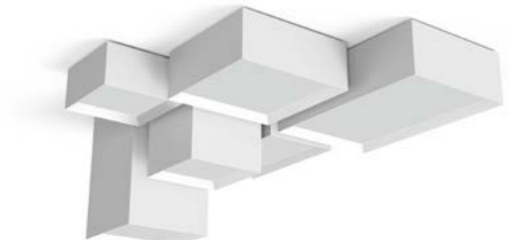

# VOLUM TRANSLUCENT

2011 by Massmi

---

Volum ceiling lamps fit perfectly in both private and contract projects. By combining different lamps of this collection we can create several compositions. Available in different translucent colors allowing light to pass through.

Los plafones Volum se integran a la perfección tanto en espacios residenciales como en proyectos contract. Permite crear composiciones muy diversas combinando las diferentes opciones de esta colección. Disponible en diferentes colores de traslúcidos, lo que favorece al paso de la luz.



Ceiling lamp  
Plafón  
Ref 3488-40 NE



Ceiling lamps / Plafones

Ref 3488-35

LED 2 x 11W **A+**

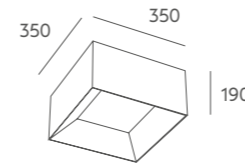

Ref 3488-40

LED 2 x 11W **A+**

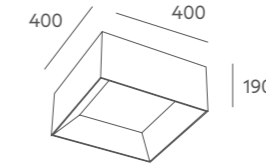

Ref 3488-50

LED 4 x 11W **A+**

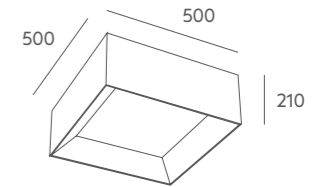

Ceiling lamps  
Plafones

Ref 3488-35 BL

Ref 3488-50 BL

Tecnical data

Details: translucent cotton lampshade. White parchment diffuser. Magnet system.

Recommended bulb: E-27 11W LED (not included).

Important: we can evaluate to change lampshade material for projects with a minimum quantity of pieces, please check with us.

Shade / Pantalla



BL

NE

Información técnica

Detalles: pantalla tela algodón traslúcido. Difusor de pergamino blanco. Sistema de sujeción de la pantalla con imanes.

Bombilla recomendada: E-27 11W LED (no incluida).

Importante: se puede valorar cambios de tela para proyectos con un mínimo de unidades, no duden en consultarnos.



# IN OPAQUE

2010 by Massmi

The word "In" reflects the main feature of this lamp, namely the slightly concave shape of the diffuser to give a "lucernario" or skylight effect. Collection of suspensions and ceiling lamps in different sizes. Its beauty lies in its simplicity and practicality with its magnet system. By combining different models we can create compositions in different heights and/or colors.

Su nombre "In" ya subraya su principal característica formal, el leve retranqueo interior del difusor buscando un efecto lucernario, además de ofrecer así una alternativa a este tipo de luminarias. Colección compuesta de plafones de techo y colgantes en distintos tamaños. Encuentra su atractivo en la simplicidad y nitidez, y su practicidad en las versiones de plafón de techo con sistema imantado. Permite combinar modelos y generar de esta manera composiciones de diversas alturas y/o colores.

MASSMI +MI



Ceiling lamp  
Plafones  
Ref 3478-40 BL  
Ref 3478-50 BL



Suspension lamps  
Lámparas de suspensión  
Ref 6942-50 CR Ref 6942-70 D

SINCE 1942

Ref 3494-40 NE-D + Ref 3494-50 NE-D



Ref 3494-50 BL-D



Ref 3494-70 BL-D



Suspension lamps / Lámparas de suspensión

Ref 6925-70 BL / NE

Ref 6942-70 BL-D / CR-D / D / NE-D \*

\* Golden interior / Interior dorado

LED 3 x 11W A+

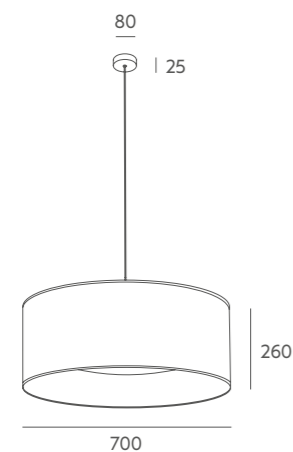

Ref 6925-50 BL / NE

Ref 6942-50 BL-D / CR-D / D / NE-D \*

\* Golden interior / Interior dorado

LED 2 x 11W A+

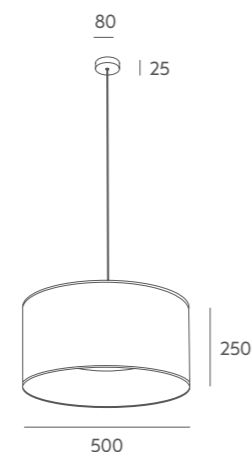

Tecnical data

Details: opaque cotton shade. White parchment diffuser. Ceiling lamp with magnet system to hang the shade. Golden outside option has beige inside.

Recommended bulb: E-27 11W LED (not included).

Important: the standard cable length is 1 metre, if you need special size please contact our Customer Support Department. We can evaluate to change lampshade material for projects with a minimum quantity of pieces, please check with us.

Información técnica

Detalles: pantalla tela algodón opaco. Difusor de pergamino blanco. Versión plafón con sistema de sujeción de la pantalla con imanes. Opción exterior dorado siempre lleva el interior crema.

Bombilla recomendada: E-27 11W LED (no incluida).

Importante: la longitud del cable estándar es de 1 metro, si desea una medida especial no dude en ponerse en contacto con nosotros. Se puede valorar cambios de tela para proyectos con un mínimo de unidades, no duden en consultarnos.

Finishes Acabados

Shade / Pantalla

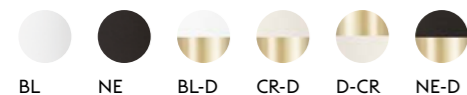

Metal Colour / Acabado Metal

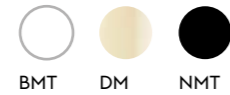

Cable / Cable



Ceiling lamps / Plafones

Ref 3494-40 BL-D / CR-D / D / NE-D \*

\* Golden interior / Interior dorado

LED 2 x 11W A+



Ref 3494-50 BL-D / CR-D / D / NE-D \*

\* Golden interior / Interior dorado

LED 2 x 11W A+

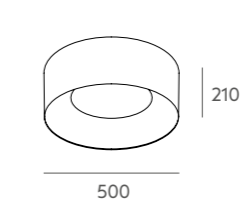

Ref 3494-70 BL-D / CR-D / D / NE-D \*

\* Golden interior / Interior dorado

LED 4 x 11W A+

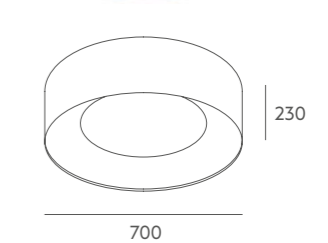

Ref 3478-40 BL / NE

LED 2 x 11W A+



Ref 3478-50 BL / NE

LED 2 x 11W A+

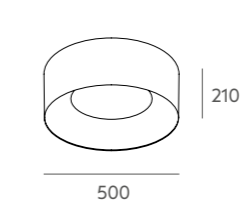

Ref 3478-70 BL / NE

LED 4 x 11W A+

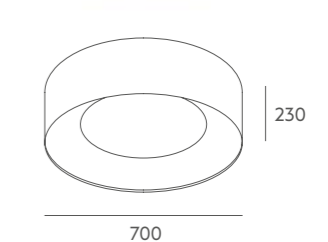

Ref 3478-100 BL / NE

LED 6 x 11W A+

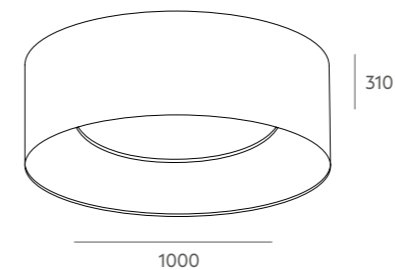

Ref 3494-100 BL-D / CR-D / NE-D \*

\* Golden interior / Interior dorado

LED 6 x 11W A+

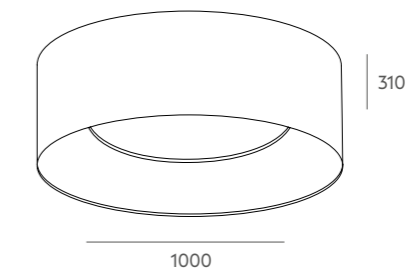

# IN TRANSLUCENT

2010 by Massmi

Used as a general piece of illumination in different kind of projects. The variety of versions allows to create several compositions. In this case, the translucent material used creates open ambiances.

Empleada como pieza de iluminación general en diversos tipos de proyectos y que, por la variedad de versiones en las que se presenta, permite crear numerosas composiciones. Este modelo, por el material traslúcido de la pantalla, permite el paso de la luz a través de ella generando ambientes diáfanos.



Ceiling lamp  
Plafón  
Ref 3477-100 BL





Suspension lamp  
Lámpara de suspensión  
Ref 6941-50 PC



Ceiling lamps  
Plafones  
Ref 3477-40 MA  
Ref 3477-70 MA

Suspension lamps / Lámparas de Suspensión

Ref 6941-50-70 Pleated / Plisado

LED 2-3 x 11W A+

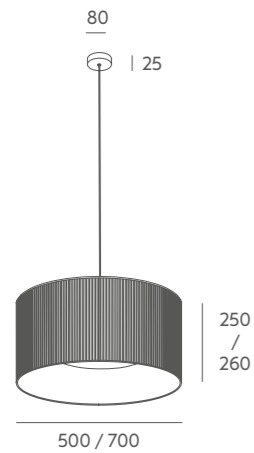

Ref 6924-50 Cotton / Algodón

LED 2x 11W A+

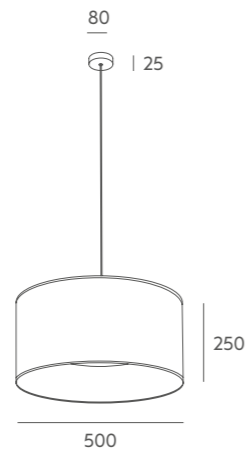

Ref 6924-70 Cotton / Algodón

LED 3 x 11W A+

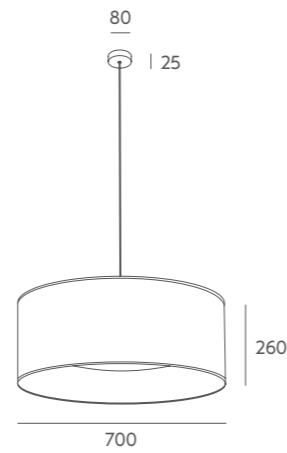

Tecnical data

Details: pleated or not cotton shade. White parchment diffuser. Suspension lamp, textil cable Ref 6924, PVC cable Ref 6941. Ceiling lamp with magnet system to hang the shade. Option with pleated outside has beige inside.

Recommended bulb: E-27 11W LED (not included).

Important: the standard cable length is 1 metre, if you need special size please contact our Customer Support Department. We can evaluate to change lampshade material for projects with a minimum quantity of pieces, please check with us.

Finishes Acabados

Shade / Pantalla



Metal Colour / Acabado Metal

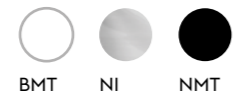

Cable / Cable

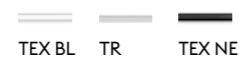

Ceiling lamps / Plafones

Ref 3477-40 Cotton / Algodón

LED 2 x 11W A+

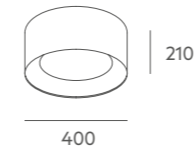

Ref 3477-50 Cotton / Algodón

LED 2 x 11W A+

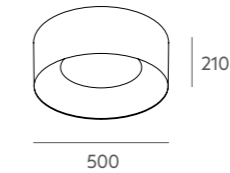

Ref 3477-70 Cotton / Algodón

LED 4 x 11W A+

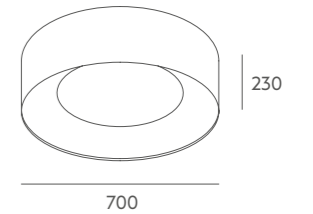

Ref 3477-100 Cotton / Algodón

LED 6 x 11W A+

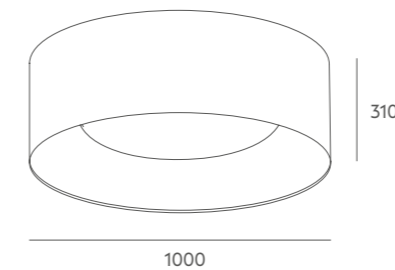

Ref 3493-40-50-70 Pleated / Plisado

LED Ø 40-50, 2 x 11W

LED Ø 70, 4 x 11W A+

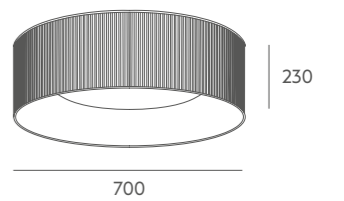
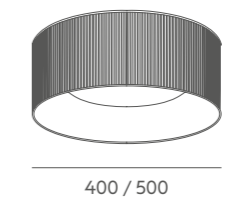

Example composition A / Ejemplo composición A

Ref 3477-40 AZ + Ref 3477-70 AZ



Example composition B / Ejemplo composición B

Ref 3477-40 MA + Ref 3477-50 AZ + Ref 3477-70 MA

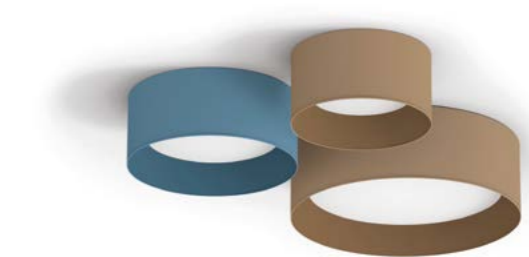

# HANG OUT

2007 by Massmi

Hang Out gives a vertical look to any space, with its illusion of solidity even as it hangs in the air. The shade has an embedded system for adjusting the height of the lamp. You can choose between a ceiling connection or a plug connection to add warmth and light to any cosy nook.

Hang Out impone verticalidad jugando entre una rotunda solidez y la ingravidez imaginaria. La pantalla incorpora en su interior un mecanismo que permite graduar su altura y es posible instalarla a techo o bien encenderla en un rincón especial, genera una luz intimista y confortable en el espacio.



Suspension lamp  
Lámpara de suspensión  
Ref 6846 C BL BMT



Suspension lamps  
Lámparas de suspensión  
Ref 6846 C NE NMT

Ref 6846 C BL NMT

Ref 6846 C BL BMT

Suspension lamp / Lámpara de suspensión

Ref 6845 C / S · Pleated / Plisado C = A plug / A enchufe S = To ceiling / A techo

Ref 6846 C / S · Cotton / Algodón

LED 2 x 11W **A+**

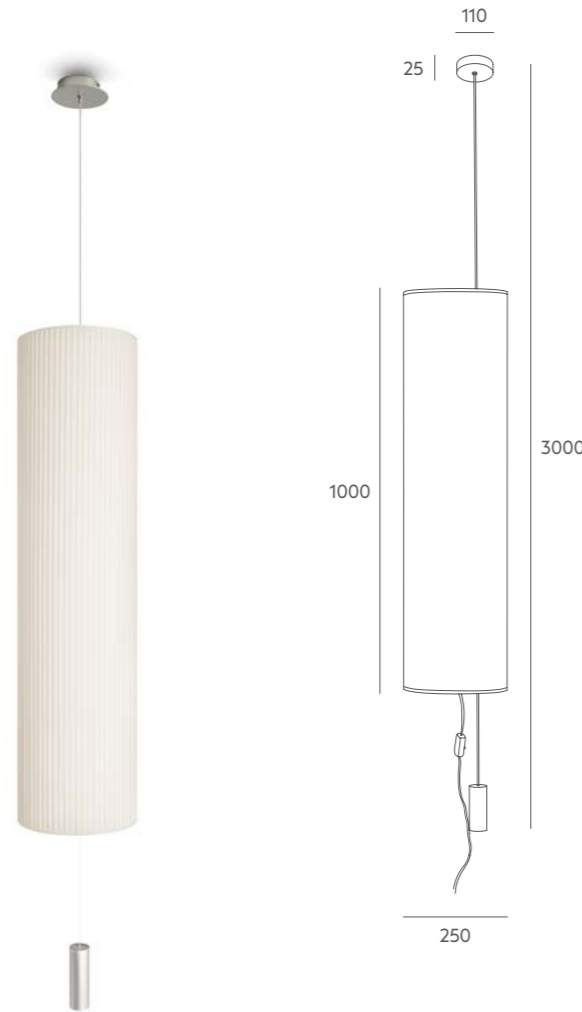

**Tecnical data**

Frame: painted iron metal or satin nickel for canopy and counterweight.

Details: translucent cotton shade or beige pleated. Up and down lighting fixture with interior mechanism and sliding steel wire. Black or transparent PVC cable.

Recommended Bulb: E-27 11W LED (not included).

Important: the standard cable length is 3 metres, if you need special size please contact our Customer Support Department.

**Finishes Acabados**

Shade / Pantalla



BL PC NE

Metal Colour / Acabado Metal



BMT NI NMT

Cable / Cable

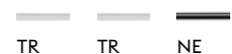

TR TR NE

**Información técnica**

Cuerpo: metal hierro pintado o níquel satinado en contrapeso y florón.

Detalles: pantalla algodón traslúcido o plisada crema. La lámpara sube y baja a través de un mecanismo interior por el que desliza el acero. Cable PVC negro o transparente.

Bombilla recomendada: E-27 11W LED (no incluida).

Importante: la longitud del cable estándar es de 3 metros, si desea una medida especial no dude en ponerse en contacto con nosotros.



Suspension lamps

Lámpara de suspensión

Ref 6845 C PC NI

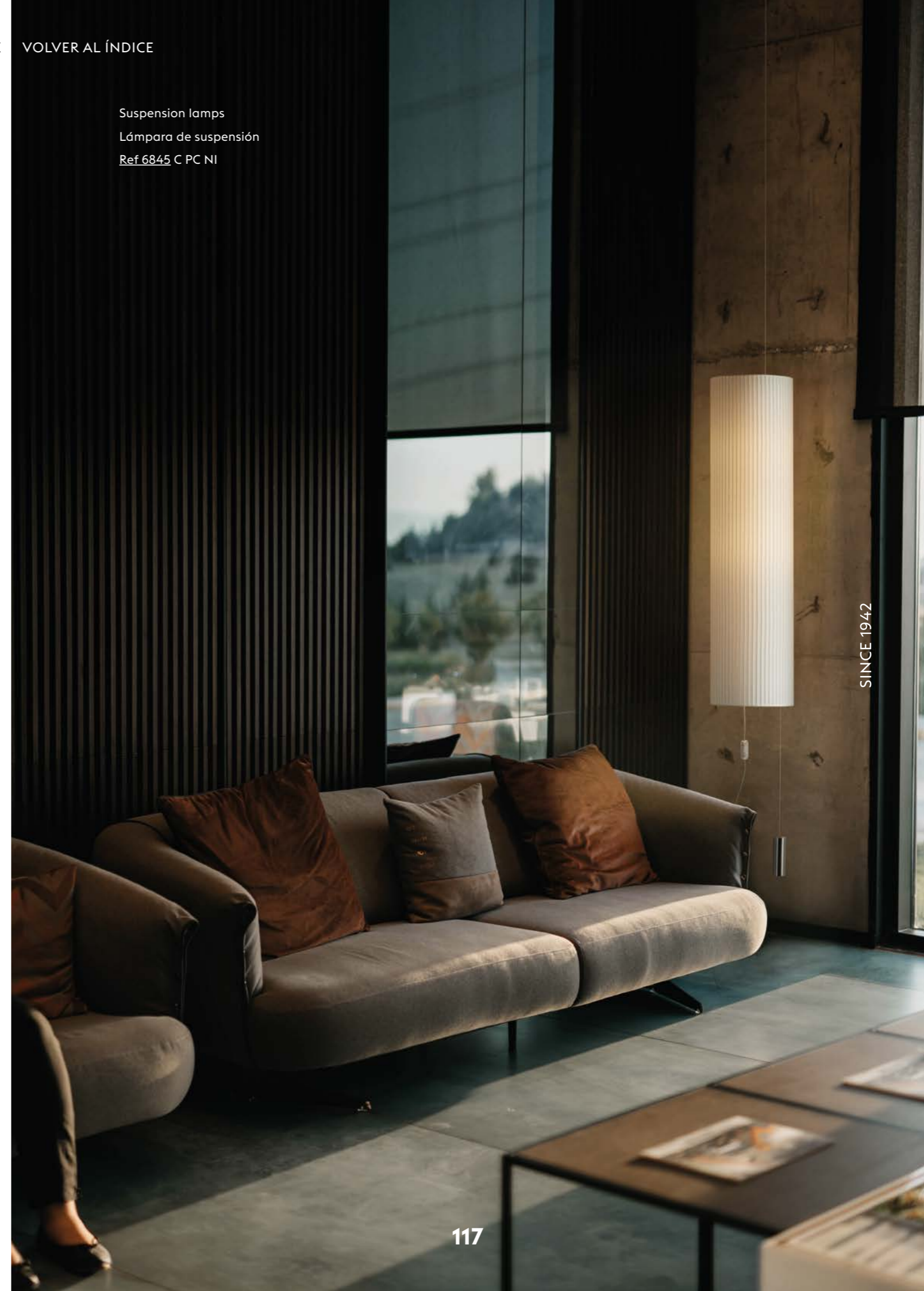

SINCE 1942

# ZESTA

2019 by Aranda Aloy Enblanc

Shows the simplicity of a metallic geometry holded to a sphere of light. Used as wall lamp or ceiling lamp, can be installed at 360° from the base, so the light will be the only protagonist.

Establece la simplicidad de una geometría metálica que abraza a una esfera de luz. Un aplique de pared o techo que, pudiéndose instalar desde su base a 360°, permite que la luz sea la única protagonista.

Project by Lázaro estudio / Proyecto de Lázaro estudio



Wall lamp  
Lámpara de pared  
Ref 1707-1 BMT

PREMIO  
ADCV  
2022  
PLATA



Ref 1707-1 MO / GA / BE

Wall lamps  
Lámparas de pared  
Ref 1707-2 BE



Wall lamp  
Lámpara de pared  
Ref 1707-1 BMT



Ceiling lamps & wall lamps  
Plafones y lámparas de pared  
Ref 1707-1 BMT / AZ / NMT / TE  
Ref 1707-2 BMT / NMT / TE



Wall lamp  
Lámpara de pared  
Ref 1707-2 TE

Ceiling lamp & wall lamp / Plafón y lámpara de pared

Ref 1707-2

LED 2 x G9 4W **A+**

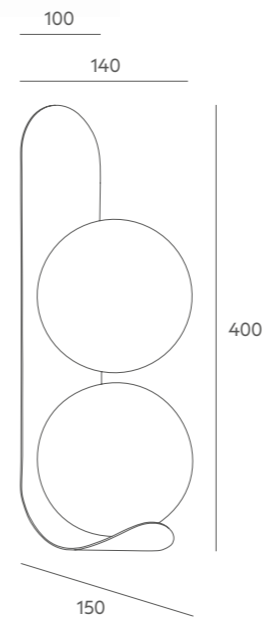

Ref 1707-1

LED 1 x G9 4W **A+**

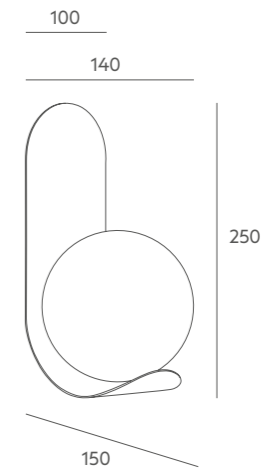
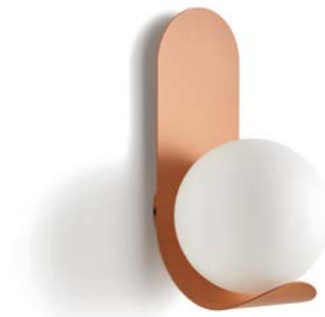

Tecnical data

Frame: painted curved iron metal.

Details: opal mate glasses fixed by clip Ø 140 mm.

Recommended Bulb: G9 4W 3000K. 400 Lm 36° LED (included).

Important: can be installed in any position, ceiling and wall. We can evaluate to change painting colour for projects with a minimum quantity of pieces, please check with us.

Información técnica

Cuerpo: metal hierro curvado pintado.

Detalles: tulipas opal mate cogida con pinzas Ø 140 mm.

Bombilla recomendada: G9 4W 3000K. 400 Lm 36° LED (incluida).

Importante: puede colocarse en cualquier posición, tanto a techo como a pared. Se puede valorar cambios de color de pintura para proyectos con un mínimo de unidades, no duden en consultarnos.

Finishes Acabados

Metal Colour / Acabado Metal



Glass / Cristal



# INFINITO

2003 by Massmi

Infinito is a timeless classic that combines form and function in its angular presentation. Versatile and elegant, Infinito is the perfect fixture for those seeking a warm light to enhance any setting.

Un clásico atemporal. Pieza angular de interioristas, Infinito aún sobriedad formal y funcional. Versátil y elegante gran aliada de quien guste una iluminación cálida y confortable.

MASSMI + MI



Table lamp  
Lámpara de pie  
Ref 4250 NMT NE

Table lamp  
Lámpara de mesa  
Ref 4250 BMT BL

Floor lamp  
Lámpara de pie  
Ref 5250 BMT BL



SINCE 1942



Suspension lamp  
Lámpara de suspensión  
Ref 6808 NI PC



Suspension lamp / Lámpara de suspensión

Ref 6808

LED 3 x 7W **A+**



Floor lamp / Lámpara de pie

Ref 5250

LED 3 x 7W **A+**



Table lamps / Lámparas de mesa

Ref 4250

LED 2 x 7W **A+**



Ref 4248

LED 2 x 7W **A+**



Tecnical data

Frame: painted or coated iron metal.

Details: translucent cotton shade. The pendant has glass diffuser. Table and floor lamps have top covers partial in same material. Complete collection has special support. Black or transparent PVC cable.

Recommended Bulb: E-27 7W LED (not included).

Important: the standard cable length is 1 metre, if you need special size please contact our Customer Support Department.

Finishes Acabados

Metal Colour / Acabado Metal

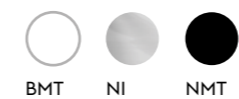

Cable / Cable

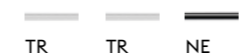

Shade / Pantalla



Información técnica

Cuerpo: metal hierro pintado o bañado.

Detalles: pantalla tela de algodón traslúcido. La suspensión lleva difusor de cristal. Las lámparas de mesa y suelo llevan tapas superiores parciales de la misma tela. Toda la familia tiene una cogida especial. Cable PVC negro o transparente.

Bombilla recomendada: E-27 7W LED (no incluida).

Importante: la longitud del cable estándar es de 1 metro, si desea una medida especial no dude en ponerse en contacto con nosotros.

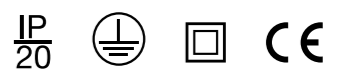

# LOULU

2001 by Massmi

Three metal tubes come together to make a teepee-like frame without the need for a solid base. Topped with an oversize lampshade available in two different materials, Loulu is an attractive lamp that goes anywhere, lending a fresh look to even the most somber space.

El triángulo que generan los tres tubos metálicos replicando la estructura de tienda de campaña india, sin necesidad de soporte en la base, junto con una generosa pantalla en dos opciones de material, proveen a Loulu de un atractivo visual y polifacético indiscutible, para crear una renovada atmósfera en espacios monótonos y asépticos.



Table Lamp  
Lámpara de mesa  
Ref 4370 BMT BL

Table lamp  
Lámpara de mesa  
Ref 4137 NMT PC

Floor lamp  
Lámpara de pie  
Ref 5370 BMT BL



Floor lamp / Lámpara de pie

Ref 5137 Pleated / Plisado Ref 5370 Cotton / Algodón

LED 3 x 11W **A+**



Table lamp / Lámpara de mesa

Ref 4137 Pleated / Plisada Ref 4370 Cotton / Algodón

LED 2 x 11W **A+**

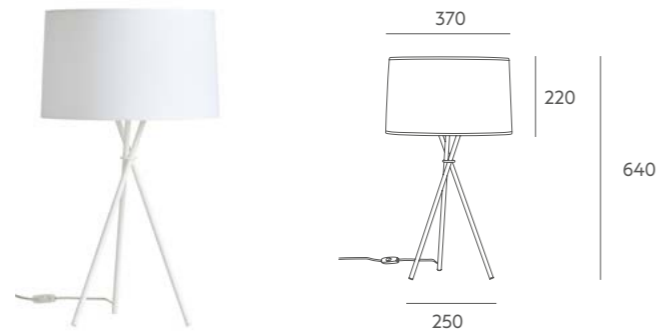

Tecnical data

Frame: painted iron metal.

Details: translucent cotton or pleated cotton Ref 4137 Ref 5137. Black or transparent PVC cable. Table lamp have top covers partial in same material.

Recommended Bulb: E-27 11W LED (not included).

Finishes Acabados

Metal Colour / Acabado Metal



BMT NMT

Cable / Cable



TR NE

Shade / Pantalla



BL NE PC PN

Información técnica

Cuerpo: metal hierro pintado.

Detalles: pantalla de algodón o plisado traslúcidos Ref 4137 Ref 5137. Cable PVC negro o transparente. La lámpara de mesa lleva tapa superior parcial de tela.

Bombilla recomendada: E-27 11W LED (no incluida).



Floor lamp  
Lámpara de pie  
Ref 5137 NMT PN

# PEA

2018 by Nacho Timón

Simple and fashionable family of lighting with nice and minimal appearance. Several peas made of glass orbit around a metallic frame. With one or two lights, it is a perfect collection to make combinations in contract projects.

Modelo sencillo y de tendencia que presenta una familia de apariencia amable y minimalista. Varios guisantes de cristal que orbitan alrededor de un ligero marco metálico. Se presenta con una o dos luces, siendo una colección ideal combinando sus modelos en proyectos e instalaciones.



Wall lamp  
Lámpara de pared  
Ref 1401 CO

Suspension lamp  
Lámpara de suspensión  
Ref 6013-1 NMT

Ref 6013-2 D

Table lamp  
Lámparas de mesa  
Ref 4408 NMT

Ref 4407-1 D

Ref 4401-1 D



Suspension lamp  
Lámpara de suspensión  
Ref 6013-1 NMT Ref 6013-2 D

PEA COLLECTION

Suspension lamp / Lámpara de suspensión

Ref 6013-2

LED 2 x G9 4W A+



Table lamp / Lámpara de mesa

Ref 4408

LED 1 x G9 4W A+

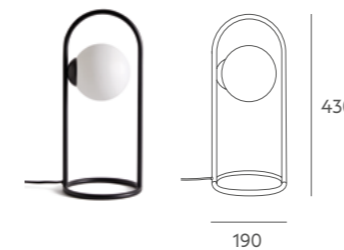

Tecnical data

Frame: welded and painted iron metal.

Details: opal mate glasses fixed by clips Ø 140 mm. Black plastic cable. Made of iron.

Recommended Bulb: G9 4W 3000K. 400 Lm 36° (included).

Importante: standard lenght of cable is 1,5 metre, if you need special lenght please contact us. We can evaluate to change colour for projects with a minimum quantity of pieces, please check with us.

Finishes Acabados

Metal Colour / Acabado Metal



Glass / Cristal



Ref 6013-1

LED 1 x G9 4W A+

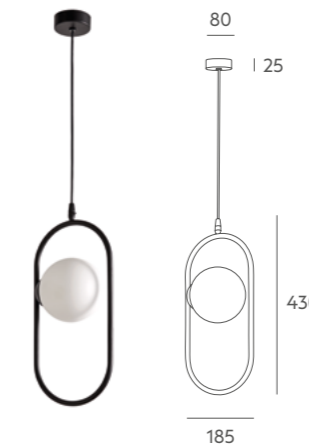

Ref 4401-1 / 4407-1 (Gold brash and black base / Brazo dorado y base negra)

LED 1 x G9 4W A+



Wall lamp / Lámpara de pared

Ref 1401

LED 1 x G9 4W A+

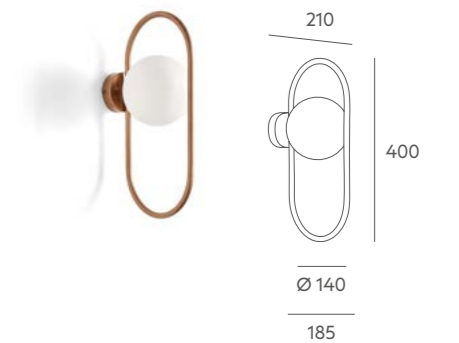

Información técnica

Cuerpo: metal hierro soldado y pintado.

Detalles: tulipas opal mate cogida con pinzas Ø 140 mm. Cable negro PVC. Base en hierro.

Bombilla recomendada: G9 4W 3000K. 400 Lm 36° (incluida).

Importante: la longitud del cable estándar es de 1,5 metro, si desea una medida especial no dude en ponerse en contacto con nosotros. Se puede valorar cambios de color para proyectos con un mínimo de unidades, no duden en consultarnos.



# LLUNA

## Reedition 1982

Sometimes the simplest things are the most durable. Lluna is inspired by a German ceiling lamp, the HL99, created in 1900. This design was an instant classic and during the Bauhaus movement, many versions of this lamp were created. LLuna carries on with this tradition, maintaining the prestige of this iconic sphere in the world of lighting decoration.

Muchas veces las cosas más simples son las más duraderas y memorables. Lluna está inspirada en una lámpara de techo alemana de 1900, la HL99. Durante ese período tanto en la Bauhaus como en otros movimientos artísticos contemporáneos, se diseñaron montones de esta versión. Así pues, con Lluna contribuimos a que la famosa "bola" continúe haciendo su magnífico papel en la iluminación de espacios contemporáneos.



Suspension lamp  
Lámpara de suspensión  
Ref 6880-40 NI

Ceiling lamp  
Plafón  
Ref 3420-20 VE

Table lamp  
Lámpara de mesa  
Ref 4239-20 VE / TE



Suspension lamps / Lámparas de suspensión

Ref 6880-40

LED 1 x 11W **A+**

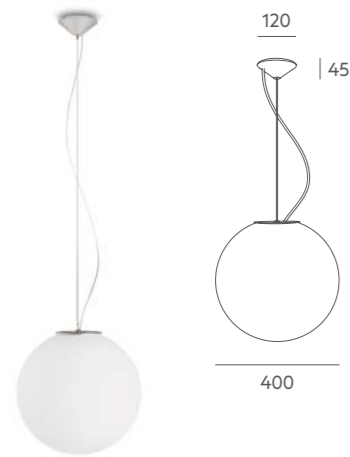

Ref 6880-35-30

LED 1 x 11W **A+**

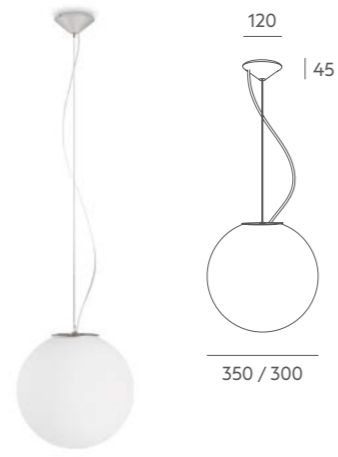

Ref 6880-25-20

LED 1 x 11W **A+**

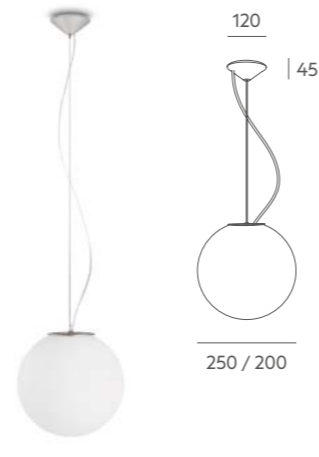

Ceiling lamp / Plafón

Ref 3420-20-30 \*

\* Ref 3420-20

Para aplique de pared sólo puede utilizarse Ref 3420-20

LED 1 x 11W **A+**

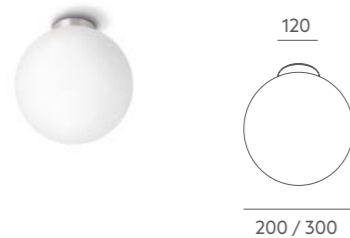

Table Lamp / Lámpara de mesa

Ref 4239-20-30

LED 1 x 11W **A+**



Tecnical data

Frame: satin nickel, satin brass colour or painted iron metal.

Details: opal mate glasses fixed by nuts (hanging lamp). By clips (plafond and table lamp). Table lamp transparent PVC cable. Suspension lamp Steel cable + transparent PVC cable.

Recommended Bulb: E-27 11W LED (not included).

Important: standard length of cable is 1 metre, if you need special length please contact us. We can evaluate to change coating or painting colour for projects with a minimum quantity of pieces, please check with us.

Información técnica

Cuerpo: metal hierro acabado níquel satinado, latón satinado o pintado en colores.

Detalles: tulipas opal mate. Cogida con tornillos (suspensión). Pinzas (plafón y mesa). Lámpara de mesa cable PVC transparente. Lámpara de suspensión cable acero + transparente PVC.

Bombilla recomendada: E-27 11W LED (no incluida).

Importante: la longitud del cable estándar es de 1 metro, si se desea una medida especial póngase en contacto con nosotros. Se puede valorar cambios en color de baño o pintura para proyectos con un mínimo de unidades, no duden en consultarnos.

Finishes Acabados

Metal Colour / Acabado Metal



Glass / Cristal



Suspension lamp  
Lámpara de suspensión  
Ref 6880-40 AZ

# MOON

Design 1950

Moon is a remake of a lamp created by the German Bauhaus school in 1900. A seductive white sphere, this lamp enhances any space. Although it has been included in the Massmi catalogue for several decades. The sphere comes in seven sizes and the bar can be cut to measure in order to facilitate different compositions and accommodate various space requirements.

Moon es la actualización de una pieza creada por la escuela alemana Bauhaus en 1900. Una esfera blanca que, sitúes donde la sitúes, seduce. Massmi la fabrica desde hace décadas. Se presenta en siete tamaños de esfera y es posible personalizar el largo de la tiza lo que permite crear composiciones y adaptarla a cualquier requerimiento espacial.



Suspension lamp  
Lámpara de suspensión  
Ref 6978-30 / 35 NMT



Suspension lamps  
Lámparas de suspensión  
Ref 6978- 20 / 25 / 30 /35 VE / AZ / MO / TE



Suspensión lamps / Lámparas de suspensión

Ref 6978-16

LED 1 x 11W **A+**

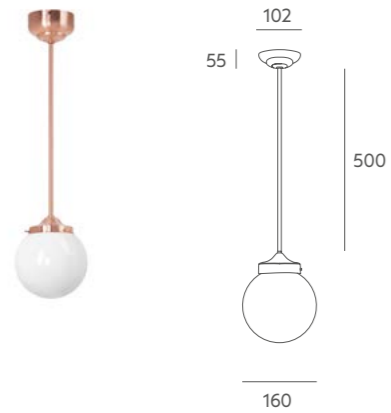

Ref 6978-18

LED 1 x 11W **A+**

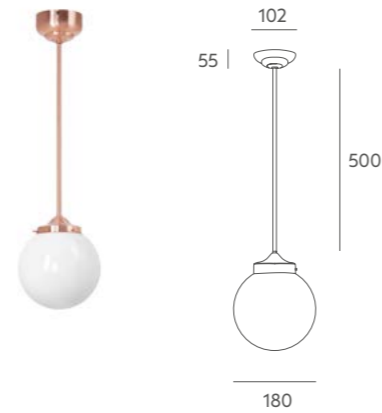

Ref 6978-20

LED 1 x 11W **A+**

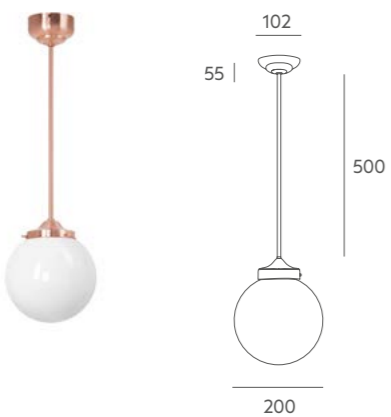

Ref 6978-25

LED 1 x 11W **A+**

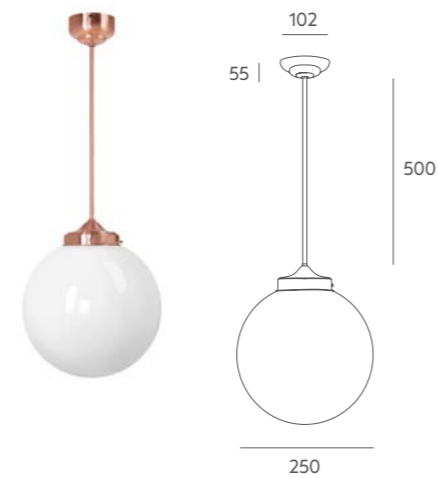

Ref 6978-30

LED 1 x 11W **A+**

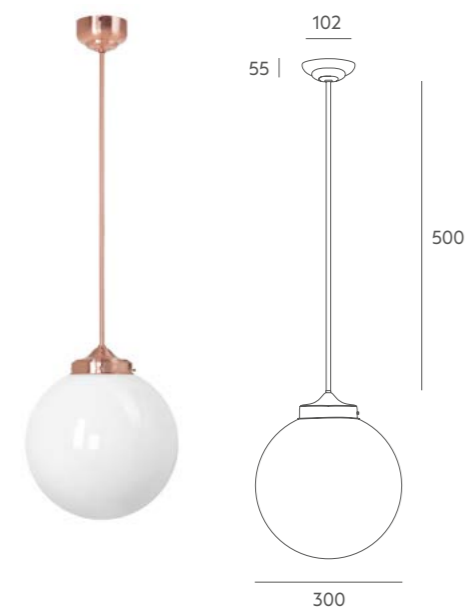

Ref 6978-35

LED 1 x 11W **A+**



Ref 6978-40

LED 1 x 11W **A+**



Tecnical data

Frame: painted or coated iron metal.

Details: opal triplex glasses fixed by nuts.

Recommended Bulb: E-27 11W LED (not included).

Important: standard metal bar is 50 cm, for special sizes contact us. We can evaluate to change coating or painting colour for project with a minimum quantity of pieces, please check with us.

Finishes Acabados

Metal Colour / Acabado Metal



Glass / Cristal



Información técnica

Cuerpo: metal hierro pintado.

Detalles: cristal opal triplex brillo cogida con tornillos.

Bombilla recomendada: E-27 11W LED (no incluida).

Importante: tiza medida estándar de 50 cm. Para medidas especiales no duden en consultarnos. Se puede valorar cambios de color baño o pintura para proyectos con un mínimo de unidades, no duden en consultarnos.





# LAFFIE

2016 Restyling by Massmi

"Laffie" triumphs in settings that call for retro-style details. Functional yet fashionable, these lamps are extremely popular both in the decoration of private homes as well as in fashionable bars throughout the world.

Laffie triunfa en ambientes que requieren un detalle de estilo retro. Funcional y estéticamente a la última, las lámparas que conforman esta colección arrasan en la decoración de interiores particulares y también en los locales de moda de medio mundo.



Detail glasses  
Detalle tulipas



Suspension lamps  
Lámparas de suspensión  
Ref 6001 TR  
Ref 6000 MT



Suspension lamps  
Lámparas de suspensión  
Ref 6010-20 TR  
Ref 6010-16 AM / AZ / TR

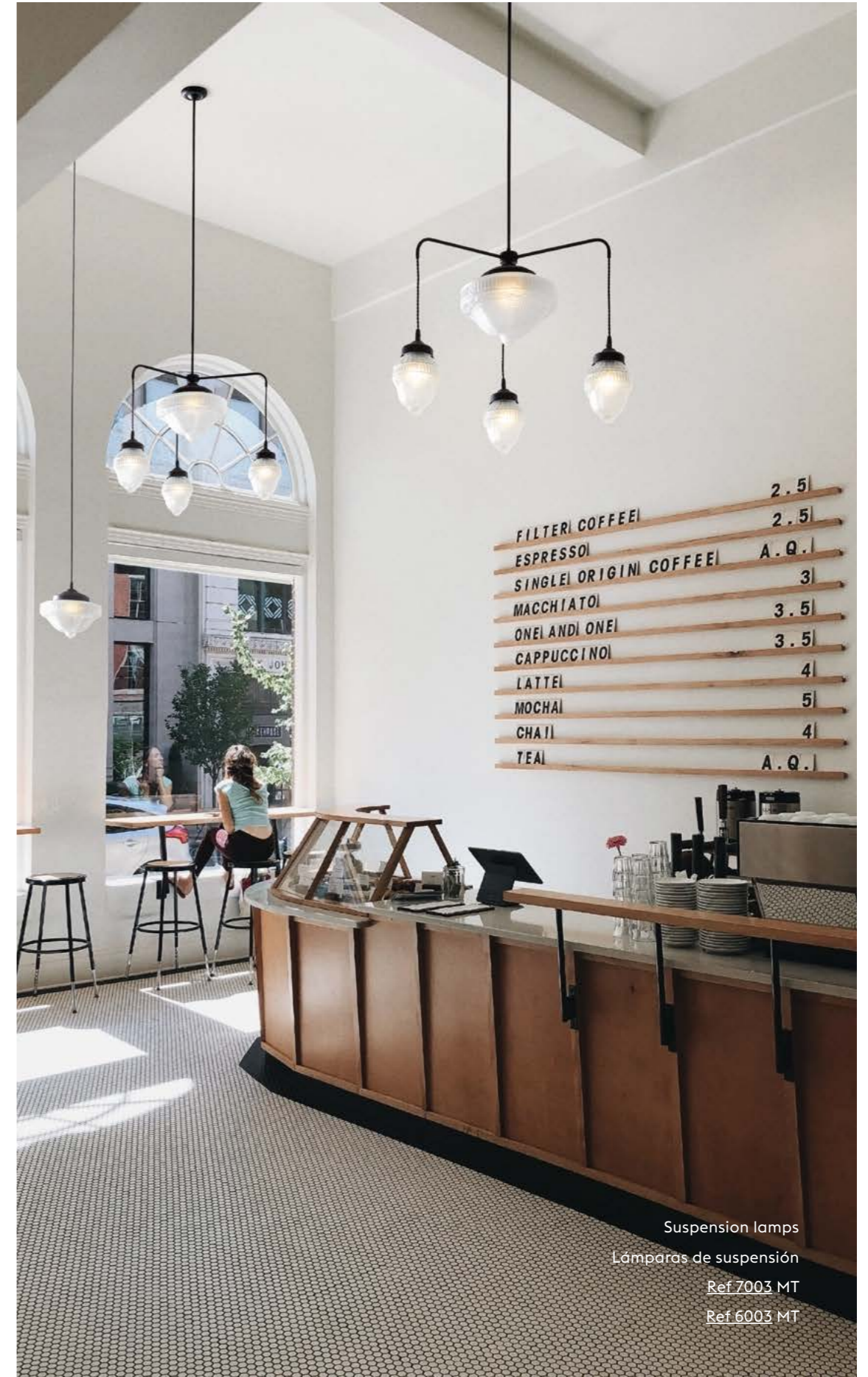

Suspension lamps  
Lámparas de suspensión  
Ref 7003 MT  
Ref 6003 MT

Suspension lamps / Lámparas de suspensión

Ref 6000

LED 1x7W **A+**

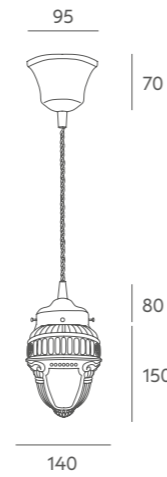

Ref 6001

LED 1x7W **A+**

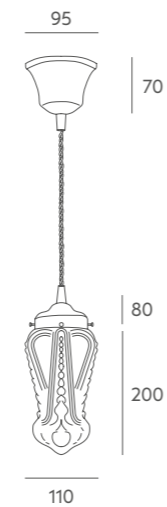

Ref 6002

LED 1x7W **A+**

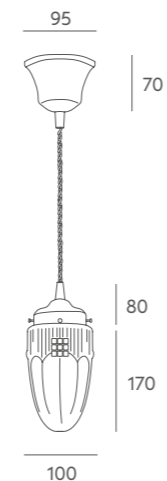

Ref 6003

LED 1x7W **A+**

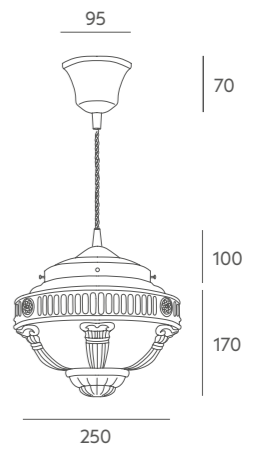

Ref 7003

LED 4x7W **A+**

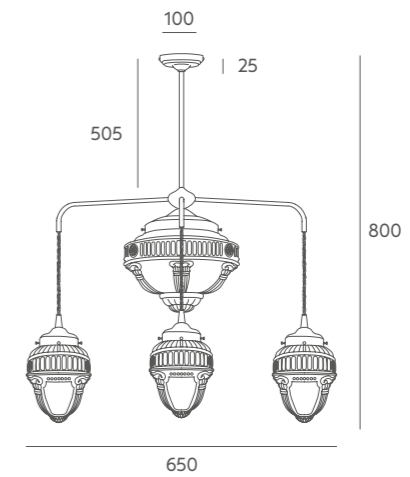

Tecnical data

Frame: painted iron metal.

Details: acid or transparent glass shades. Black plaited cable.

Recommended Bulb: E-27 7W (not included).

Important: the standard cable length is 1 metre, if you need special size please contact our Customer Support Department. Ref: 7003 standard metal bar is 50 cm, for special sizes contact us. We can evaluate to change coating or painting colour for project with a minimum quantity of pieces, please check with us.

Finishes Acabados

Metal Colour / Acabado Metal



NMT

Glass / Cristal



MT TR

Información técnica

Cuerpo: metal hierro pintado.

Detalles: tulipas de cristal al ácido (MT) o transparentes. Cable trenzado negro.

Bombilla recomendada: E-27 7W (no incluida).

Importante: la longitud del cable estándar es de 1 metro, si desea una medida especial no dude en ponerse en contacto con nosotros. Ref: 7003 tiza medida estándar de 50 cm. Para medidas especiales no duden en consultarnos. Se puede valorar cambios de color baño o pintura para proyectos con un mínimo de unidades, no duden en consultarnos.

Suspension lamps / Lámparas de suspensión

Ref 6010-30

LED 1x7W **A+**



Ref 6010-20

LED 1x7W **A+**

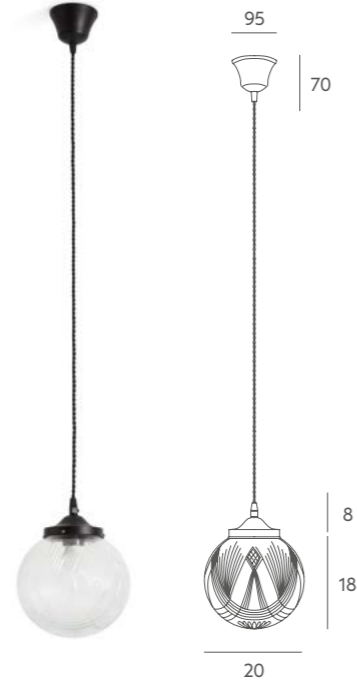

Ref 6010-16

LED 1x7W **A+**

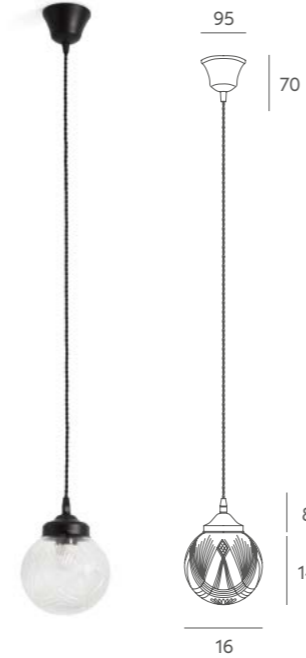

Tecnical data

Frame: painted iron metal.

Details: color or transparent glass shades. Black plaited cable.

Recommended Bulb: E-27 7W (not included).

Important: the standard cable length is 1 metre, if you need special size please contact our Customer Support Department. We can value colour changes for projects with a minimum quantity.

Finishes Acabados

Metal Colour / Acabado Metal



NMT

Glass / Cristal



AM



AZ



TR

Información técnica

Cuerpo: metal hierro pintado.

Detalles: tulipas de cristal de color. Cable trenzado negro.

Bombilla recomendada: E-27 7W (no incluida).

Importante: la longitud del cable estándar es de 1 metro, si desea una medida especial no dude en ponerse en contacto con nosotros. Se puede valorar cambios de color para proyectos con un mínimo de unidades.



Details glasses  
Detalles tulipas

# BULB

2015 by Massmi

Bulb fits in anywhere. The natural essence of Bulb emanates from the simplicity of its beechwood socket. The different combinations made possible by the two socket and bulb size options help create elegant lighting fixture compositions.

Las Bulb encajan en todo tipo de ambientes. La sencillez del portalámparas en madera de Haya es toda su esencia y naturalidad. Se presenta en dos formatos, que combinados crean sutiles y elegantes composiciones.



Suspension lamp  
Lámpara de suspensión  
[Ref 6992 A HA](#) [Ref 6992 HA NE](#) [Ref 6991 B HA](#) [Ref 6992 D HA](#) [Ref 6991 A HA](#)



Suspension lamps  
Lámparas de suspensión  
Ref 6991 D HA Ref 6992 D HA

Suspension Lamp / Lámpara de suspensión

Ref 6992 D HA

1 x 40W **A+**

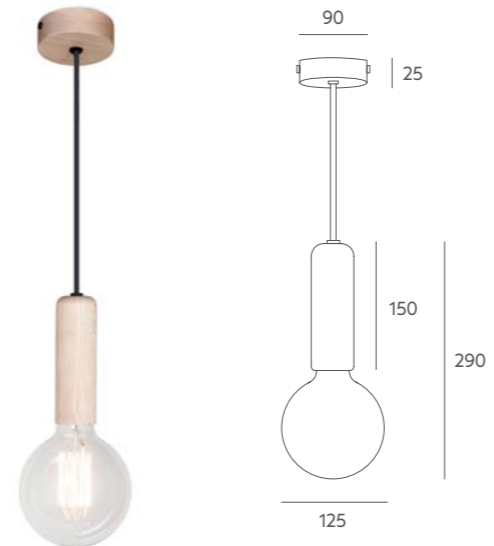

Ref 6991 D HA-NE

1 x 40W **A+**

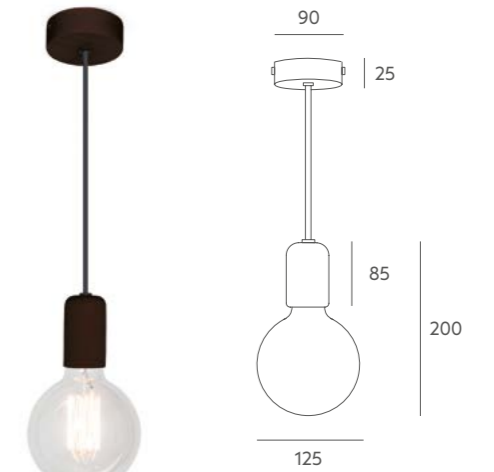

Bulbs / Bombillas

A

LED 1 x 6W **A+**



B

LED 1 x 6W **A+**



D

1 x 40W **A+**



Technical data

Frame: varnished beech wood.

Recommended Bulb: A, B, E-27 6W LED o D E-27 40W Nostalgic Edison bulb (included).

Important: the standard cable length is 1 metre, if you need special size please contact our Customer Support Department.

Finishes Acabados

Wood / Madera

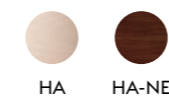

Información técnica

Cuerpo: madera de haya barnizada.

Bombilla recomendada: A, B, E-27 6W LED o D E-27 40W Bombilla nostálgica Edison (incluida).

Importante: la longitud del cable estándar es de 1 metro, si desea una medida especial no dude en ponerse en contacto con nosotros.





# KANATAN

2021 by Massmi

A meeting between past and present by combining materials. The lampshade made with an upholstered parchment creates a contrast with the black metal body. It's a bet to obtain modern places with an artisan touch.

Un punto de encuentro entre el pasado y el presente a través de la combinación de los materiales que la conforman. Un pergamino tapizado da forma a la pantalla creando de esta manera un contraste con el cuerpo de metal de acabado negro mate. Apuesta por crear espacios modernos con un pequeño toque artesanal.



Table lamp  
Lámpara de mesa  
Ref 4464



Suspension lamp  
Lámpara de suspensión  
Ref 6863

Table lamps  
Lámparas de mesa  
Ref 4463 Ref 4464

Wall lamp  
Lámpara de pared  
Ref 1463

Floor lamp  
Lámpara de pie  
Ref 5463

Suspension lamp / Lámpara de suspensión

Ref 6863

LED 1 x 11W **A+** 



Floor lamp / Lámpara de pie

Ref 5463

LED 1 x 11W **A+** 



Wall lamp / Lámpara de pared

Ref 1463

LED 1 x 11W **A+**  

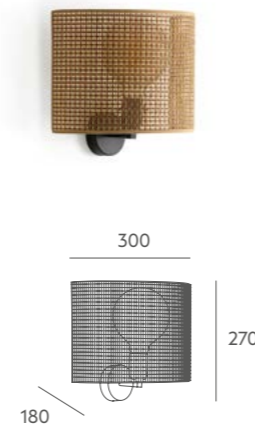

Table lamps / Lámparas de mesa

Ref 4464

LED 1 x 11W **A+** 



Ref 4463

LED 1 x 11W **A+** 



Tecnical data

Frame: painted iron metal.

Details: grating shade. Black PVC cable.

Recommended Bulb: E-27 11W LED (not included).

Important: the standard cable length is 1 metre, if you need special size please contact our Customer Support Department.

Información técnica

Cuerpo: metal hierro pintado.

Detalles: pantalla rejilla. Cable PVC negro.

Bombilla recomendada: E-27 11W LED (no incluida).

Importante: la longitud del cable estándar es de 1 metro, si desea una medida especial no dude en ponerse en contacto con nosotros.

Finishes Acabados

Metal Colour / Acabado Metal



NMT

Shade / Pantalla



RE



Suspension lamps  
Lámparas de suspensión  
Ref 6863

# HOLD

2008 by Massmi

Depending on how you look at it, Hold is a table-lamp or a lamp-table, a deft update of the classic wooden side table complete with its own light. Perfect to use next to a bed or armchair, Hold fulfills its role with simple elegance.

Hold es una mesita auxiliar con lámpara incorporada o viceversa, una sencilla y actual revisión del clásico velador de madera con luz. Reduciendo la forma de este eterno mueble auxiliar a la esencia máxima, funciona tanto como mesilla de noche, al lado de la cama, o como mesilla de salón, al lado del sofá. Hold es honesto y cumple con su función.

MASSMI + MI



Oak finish  
Acabado roble



Floor lamps  
Lámparas de pie  
Ref 5382 BMT BL BL  
Ref 5382 NMT RO NE

SINCE 1942

Floor lamp / Lámpara de pie

Ref 5382

LED 1 x 11W **A+**

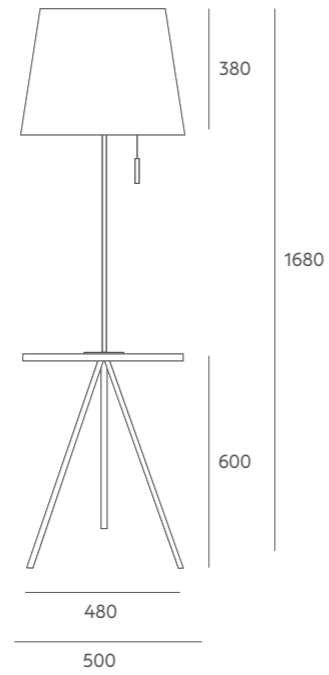

Tecnical data

Frame: painted iron metal. Lacquered wood table or oak.

Details: cotton shade. Black or transparent PVC cable. Chain switch with painted handle.

Recommended Bulb: E-27 11W LED ( not included).

Finishes Acabados

Metal Colour / Acabado Metal



Cable / Cable

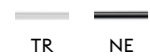

Wood / Madera



Shade / Pantalla



Información técnica

Cuerpo: metal hierro pintado. Mesa de madera lacada blanca o acabado roble.

Detalles: pantalla tela de algodón. Cable PVC negro o transparente. Interruptor de tirador con detalle lacado.

Bombilla recomendada: E-27 11W LED (no incluida).



Floor lamp  
Lámpara de pie  
Ref 5382 NMT RO NE

# ATHINA

2016 by Massmi

---

Athina combines a satin steel or painted base with a cylindrical cloth shade that seems to float in the air while the play of light and shadow firmly grounds the structure. Athina is a contemporary collection of lighting.

Athina combina el acero satinado o pintado con la tela de una pantalla cilíndrica de sujeción interna que parece flotar en el aire, mientras su sombra proyectada en la base la afianza en el suelo. Athina es una colección de lámparas con un marcado acento contemporáneo.

Floor lamp  
Lámpara de pie  
Ref 5456 BMT BL

Ref 4456 NMT NE

Table lamps  
Lámparas de mesa  
Ref 4456 BMT BL



Floor lamp  
Lámpara de pie  
Ref 5456 NMT NE



Floor lamp / Lámpara de pie

Ref 5456

LED 1 x 11W **A+**



Table lamp / Lámpara de mesa

Ref 4456

LED 1 x 7W **A+**



Tecnical data

Frame: painted or coated iron metal.

Details: translucent cotton shade. Empty bases by laser cut. Black or transparent PVC cable.

Recommended Bulb: E-27 7W or 11W LED (not included).

Important: we can evaluate to change coating or painting colour for project with a minimum quantity of pieces, please check with us.

Finishes Acabados

Metal Colour / Acabado Metal

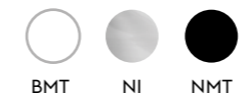

Shade / Pantalla



Cable / Cable

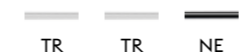

Información técnica

Cuerpo: metal hierro pintado o bañado.

Details: pantalla tela de algodón traslucido. Bases vacías en su interior cortadas a láser. Cable PVC negro o transparente.

Bombilla recomendada: E-27 7W o 11W LED (no incluida).

Importante: se puede valorar cambios de color baño o pintura para proyectos con un mínimo de unidades, no duden en consultarnos.



# FUSTA

2011 by Nacho Timón

Fusta is a modern and elegant collection of lighting fixtures that incorporates a lamp into an actual side table. Fusta is the perfect lamp to put either next to a sofa or armchair or to adorn a special reading nook. It embodies practicality at its best.

Fusta aporta una versión racional, moderna y elegante a este tipo de luminarias que integran mueble auxiliar y lámpara. Situada en un rincón de lectura, junto a una butaca o a orillas del sofá es sorprendentemente funcional.

MASSMI + MI



Oak finish  
Acabado roble

Floor lamps  
Lámparas de pie  
Ref 5390 RO Ref 5391 BL



SINCE 1942

Floor lamp / Lámpara de pie

Ref 5390

LED 1 x 11W **A+**

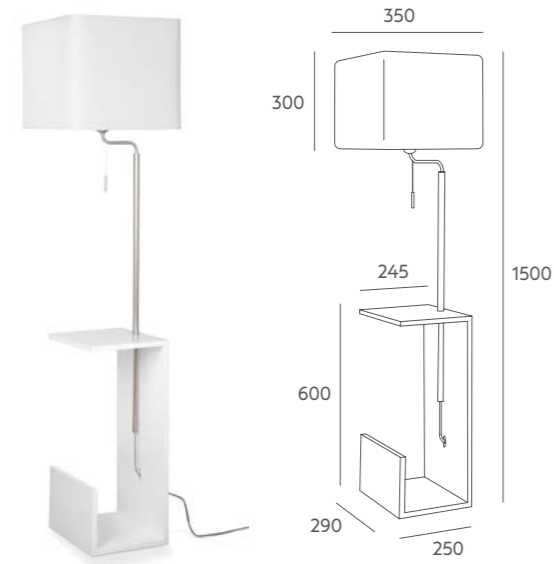

Ref 5391

LED 1 x 11W **A+**

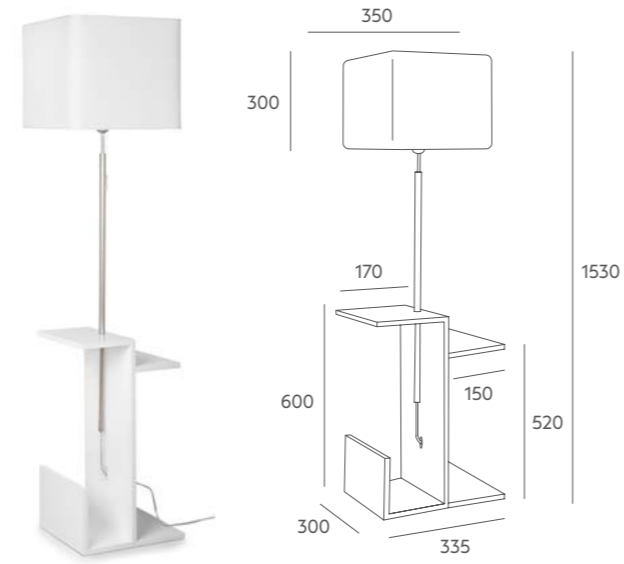

Tecnical data

Frame: satin nickel iron metal. Lacquered wood table or oak.

Details: white cotton shade with top diffuser (partial).  
Transparent PVC cable. Satin nickel chain switch.

Recommended Bulb: E-27 11W LED ( not included).

Finishes Acabados

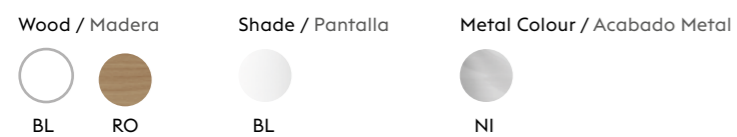

Información técnica

Cuerpo: metal hierro acabado en niquel satinado. Mesa de madera lacada o roble.

Detalles: pantalla algodón con difusor superior parcial.  
Cable transparent PVC. Interruptor de tirador con detalle en niquel satinado.

Bombilla recomendada: E-27 11W LED (no incluida).

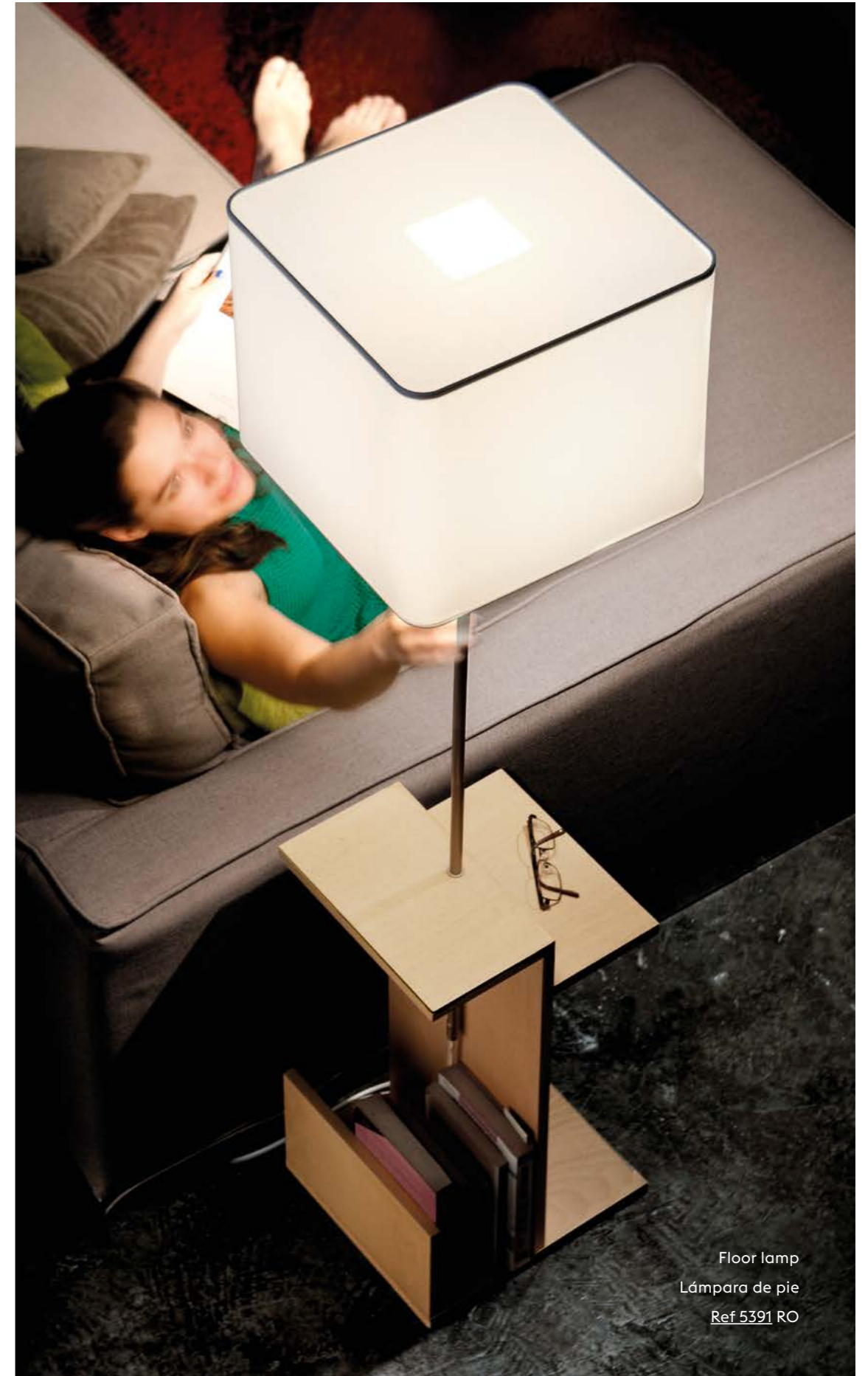

Floor lamp  
Lámpara de pie  
Ref 5391 RO



# MINA

2012 by Massmi

Mina has a simple, double-jointed mechanism that makes this lamp fully adjustable. The shade pivots in a 90° angle to focus the light in any direction. Its airy design gives Mina a familiar look, but with a personality all its own.

El sencillo mecanismo de Mina se consigue mediante una doble rótula en su brazo que permite cambiar la altura de la pantalla para adaptarse a las necesidades del usuario. La pantalla ofrece una rotación de 90° para dirigir el haz de luz hacia donde convenga. La ligereza de su estructura confieren a Mina un aire próximo y a la vez una marcada personalidad.



Floor lamp  
Lámpara de pie  
Ref 5393\_NMT NE

MASSMI + MI

SINCE 1942

## MINA COLLECTION

Floor lamp / Lámpara de pie

Ref 5393 BMT

LED 1 x 11W **A+**



Ref 5393 NI

LED 1 x 11W **A+**



Ref 5393 NMT

LED 1 x 11W **A+**

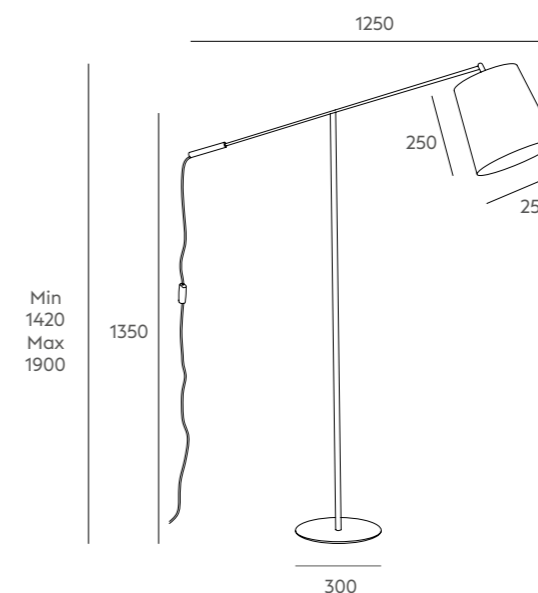

### Tecnical data

Frame: painted or coated iron metal.

Details: white or black opaque cotton shade. Adjustable lighting fixture. Black or transparent PVC cable.

Recommended Bulb: E-27 11W LED (not included).

### Finishes Acabados

Metal Colour / Acabado Metal



Shade / Pantalla



Cable / Cable

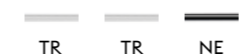

### Información técnica

Cuerpo: metal hierro pintado o bañado.

Detalles: pantalla tela de algodón opaco blanco o negro. Lámpara basculante y orientable. Cable PVC negro o transparente.

Bombilla recomendada: E-27 11W LED (no incluida).



# MANHATTAN

2021 by Massmi

Manhattan enriches the space using concret materials: the pleated parchment as artisan work and metal in the opposite. Simplicity, elegance and timelessness are the main features.

Manhattan enriquece el espacio con el uso de materiales por los que apuesta este diseño. Utiliza pergamino plisado que nos traslada en el tiempo, creando un punto de inflexión al combinarlo con el metal. Sencillez, elegancia y atemporalidad definen la colección.



Pleated parchment detail  
Detalle pergamino plisado

Suspension lamp  
Lámpara de suspensión  
[Ref 6865](#)

Ceiling lamps  
Plafones  
[Ref 3505-25-50](#)

Table lamps  
Lámparas de mesa  
[Ref 4466](#)  
[Ref 4465](#)

Wall lamp  
Lámpara de pared  
[Ref 1505](#)

Floor lamp  
Lámpara de pie  
[Ref 5465](#)





Table lamp  
Lámpara de mesa  
Ref 4465

Suspension lamp / Lámpara de suspensión

Ref 6865

LED 1 x 11W **A+**



Tables lamp / Lámparas de mesa

Ref 4466

LED 1 x 11W **A+**



Floor lamp / Lámpara de pie

Ref 5465

LED 1 x 11W **A+**



Ref 4465

LED 1 x 11W **A+**



Wall lamp / Lámpara de pared

Ref 1505

LED 1 x 11W **A+**

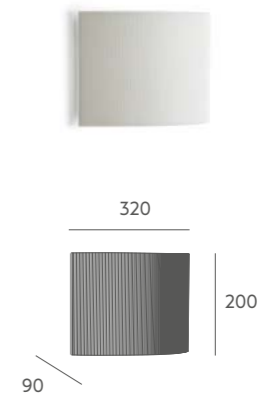

Ceiling lamp / Plafón

Ref 3505

LED Ø 25, 2 x 7W

LED Ø 50, 2 x 11W

LED Ø 70, 4 x 11W **A+**

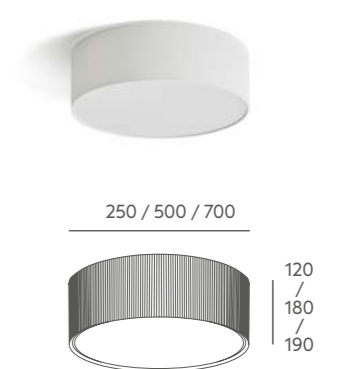

Tecnical data

Frame: painted iron metal.

Details: pleated parchment shade. Black PVC cable. Ceiling lamp with stone sockets and magnet system to hang the shade.

Recommended Bulb: E-27 7W or 11W LED (not included).

Important: standard length of wire is 1 metre, if you need special length please contact us.

Finishes Acabados

Metal Colour / Acabado Metal



Shade / Pantalla



Información técnica

Cuerpo: metal hierro pintado.

Detalles: pantalla pergamino plisado. Cable PVC negro. Versión plafón, difusor de pergamino blanco. portalámparas de piedra y sistema de sujeción de la pantalla con imanes.

Bombilla recomendada: E-27 7W o 11W LED (no incluida).

Importante: la longitud del cable estándar es de 1 metro, si se desea una medida especial póngase en contacto con nosotros.



# BLUR

2010 by Massmi

Inspired by the curved volumes of the Guggenheim Museum, Blur plays with the irregular halos of light that emanate from its multitiered, cone-shaped shade.

Inspirada en los juegos de volúmenes curvilíneos del museo Guggenheim, Blur juega divertida con el desenfoco que producen los halos de luz superpuestos y desiguales de su estructura cónica escalonada.



Shade detail  
Detalle pantalla



Suspension Lamp  
Lámpara de suspensión  
Ref 6930 BL



Suspension lamp  
Lámpara de suspensión  
Ref 6930 NE

Suspension lamp / Lámpara de suspensión

Ref 6930

LED 1 x 11W A+

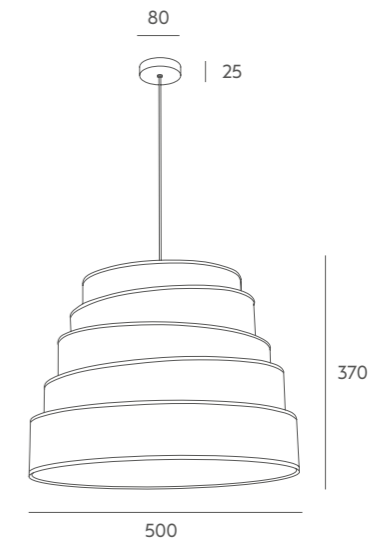

Tecnical data

Details: opaque cotton shade with diffuser of white parchment. Black or white textil cable.

Recommended Bulb: E-27 11W LED (not included).

Important: the standard cable length is 1 metre, if you need special size please contact our Customer Support Department.

Finishes Acabados

Metal Colour / Acabado Metal



BMT NMT

Shade / Pantalla



BL NE

Cable / Cable



TEX BL TEX NE

Información técnica

Detalles: pantalla tela algodón opaco con difusor de pergamino blanco. Cable textil color blanco o negro.

Bombilla recomendada: E-27 11W LED (no incluida).

Importante: la longitud del cable estándar es de 1 metro, si desea una medida especial no dude en ponerse en contacto con nosotros.



# BORROCO

2006 by Massmi

Borroco marks a return to the sophistication of an iconic lighting fixture. Today, this lamp continues to be a classic in our catalogue. Fully updated, Borroco is a complete series with table, and pendant lamp models. The series brings back the luxury of the gold tone of yesteryear and we add new colors.

Borroco fue en su día un retorno a la sofisticación y una actualización de la iconografía clásica en iluminación. Ha logrado sostenerse como un clásico en el corazón de nuestro catálogo. La presentamos actualizada en sus diferentes versiones de sobremesa y de techo, apostando por el lujo accesible que recupera en la decoración los dorados de siempre y se añaden nuevos colores.

MASSMI + MI



Ceiling Lamp  
Suspensión  
Ref 6854 NMT NE



Suspension lamp  
Lámpara de suspensión  
Ref 6854 D BL

Table lamp  
Lámpara de mesa  
Ref 4454 D BL

SINCE 1942

Table lamps / Lámparas de mesa

Ref 4455

LED 1 x 11W **A+**

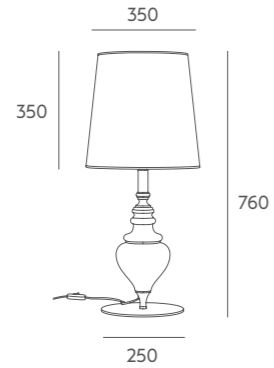

Ref 4454

LED 1 x 11W **A+**

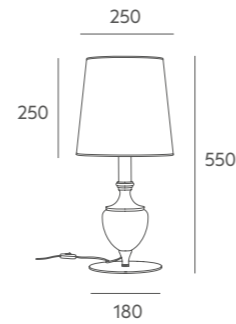

Suspension lamp / Lámpara de suspensión

Ref 6854

LED 1 x 11W **A+**

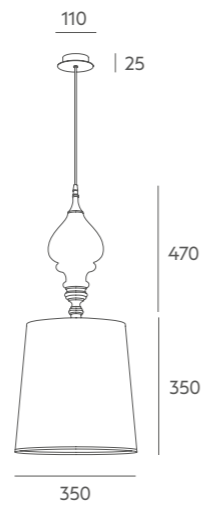

Tecnical data

Frame: painted iron metal.

Details: opaque cotton shade. Textil black or white cable for suspension lamp. Table lamp black or transparent PVC cable.

Recommended Bulb: E-27 11W LED (not included).

Important: the standard cable length is 1 metre, if you need special size please contact our Customer Support Department.

Finishes Acabados

Metal Colour / Acabado Metal



Shade / Pantalla



Cable / Cable



Información técnica

Cuerpo: metal hierro pintado.

Detalles: pantalla tela de algodón traslúcido. Cable textil negro o blanco en lámpara de suspensión. Lámpara de mesa cable PVC transparente o negro.

Bombilla recomendada: E-27 11W LED (no incluida).

Importante: la longitud del cable estándar es de 1 metro, si desea una medida especial no dude en ponerse en contacto con nosotros.



Table lamp  
Lámpara de mesa  
Ref 4455 BMT BL





# HAT

## Restyling 2012

"Hat" is inspired by one of the most important design styles of the mid-twentieth century, California Modernism. The tripod-shaped tubular base inclines slightly backwards, with the articulated axis allowing for full adjustment of the shade.

Hat se inspira en uno de los estilos más relevantes del diseño de mediados del siglo XX, el modernismo californiano. La pantalla se orienta desde una rótula que puede ser direccionada allí donde sea necesaria la luz.

Suspension lamps  
Lámparas de suspensión  
[Ref 6953\\_VE / AZ](#)

Floor lamps  
Lámparas de pie  
[Ref 5383\\_VE / AZ / BMT](#)

Table lamps  
Lámparas de mesa  
[Ref 4425\\_BMT / NMT](#)



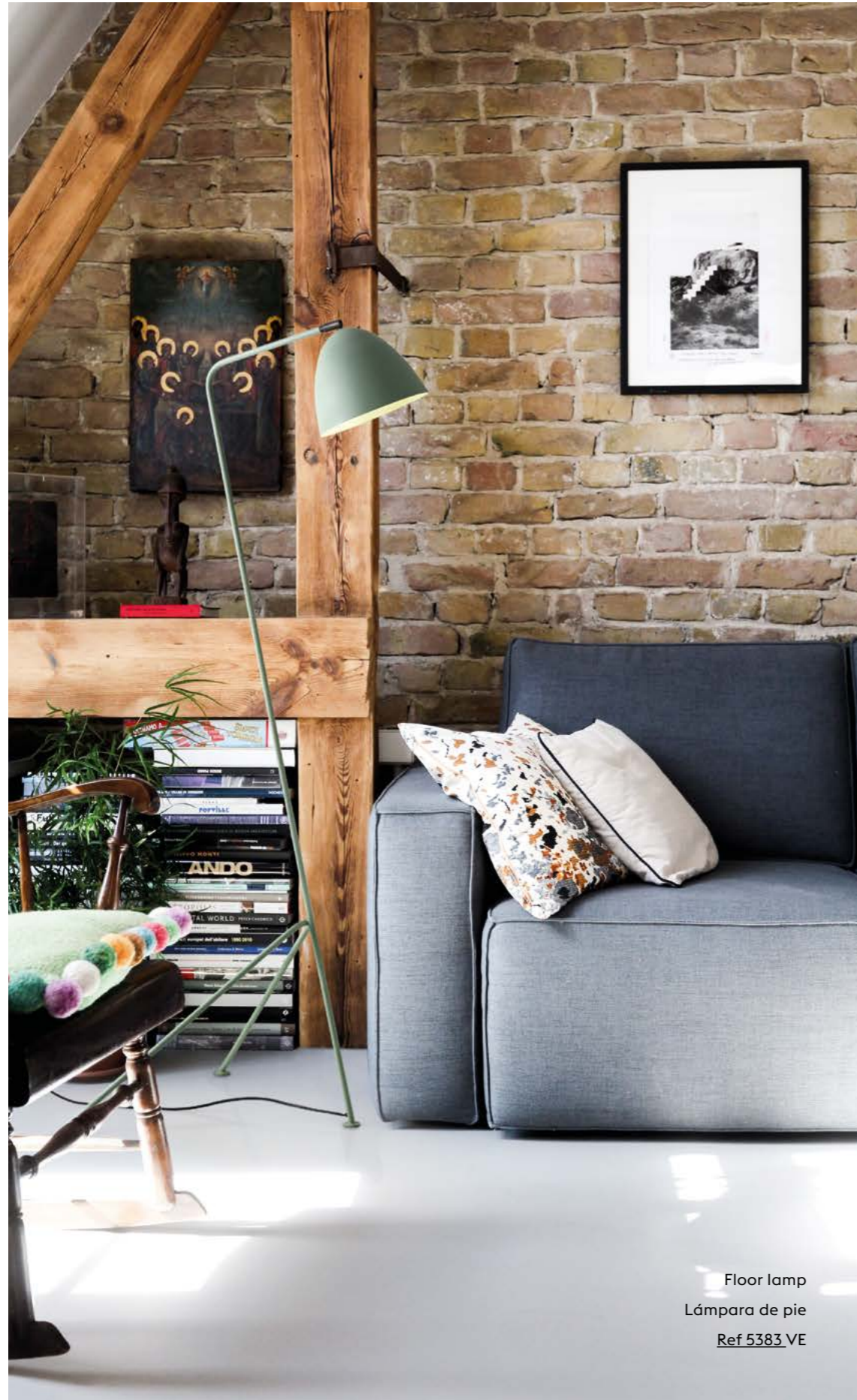

Floor lamp  
Lámpara de pie  
[Ref 5383 VE](#)

Suspension lamps / Lámpara de suspensión

[Ref 6953](#)

LED 1 x 11W **A+**

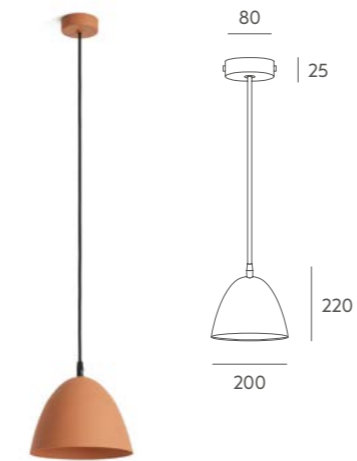
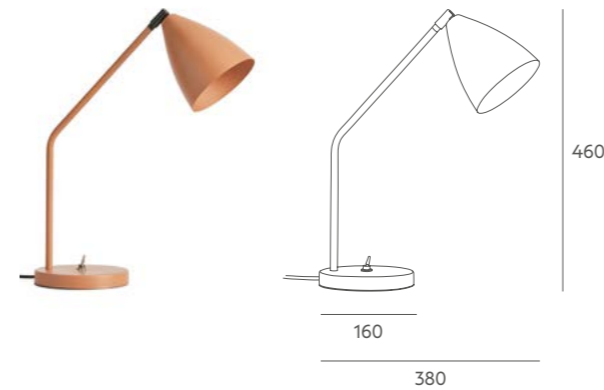

Table lamp / Lámpara de mesa

[Ref 4425](#)

LED 1 x 11W **A+**



Floor lamp / Lámpara de pie

[Ref 5383](#)

LED 1 x 11W **A+**

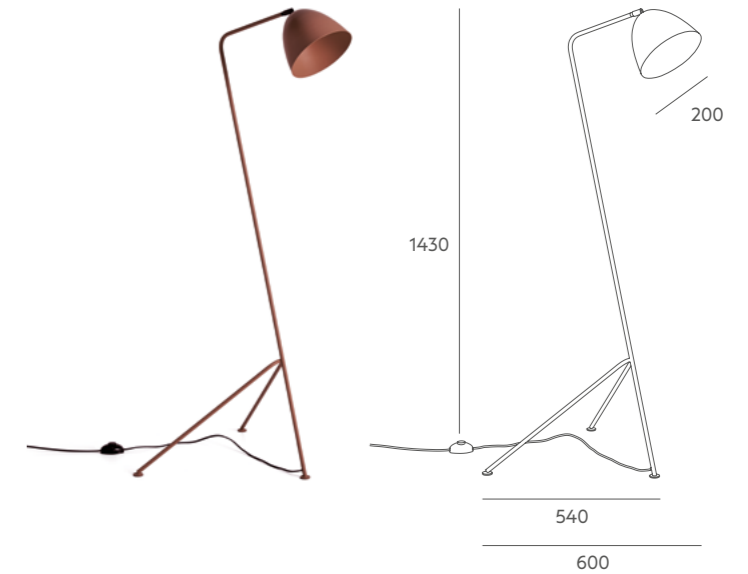

Tecnical data

Frame: painted iron metal.

Details: same coloured inside and outside. Black or transparent PVC cable. Black textile cable for suspension lamps.

Recommended Bulb: E-27 11W LED (not included).

Important: the standard cable length is 1 metre, if you need special size please contact our Customer Support Department. We can value colour changes for projects with a minimum quantity.

Finishes Acabados

Metal Colour / Acabado Metal



Información técnica

Cuerpo: metal hierro pintado.

Detalles: acabado interior mismo color que exterior. Cable PVC negro. Cable textil negro para lámparas de suspensión.

Bombilla recomendada: E-27 11W LED (no incluida).

Importante: la longitud del cable estándar es de 1 metro, si desea una medida especial no dude en ponerse en contacto con nosotros. Se puede valorar cambios de color para proyectos con un mínimo de unidades.



# EXA

2017 by Massmi

Exa is an extensive collection with simple and marked lines. Perfect to create modern and elegant ambiances. Despite simplicity and minimal aesthetic it gives personallity to the space and can be used in any kind of interior projects.

Exa es una amplia colección de líneas limpias y marcadas ideal para crear ambientes modernos y elegantes. Pese a su simplicidad y estética minimalista, dota de mucha personalidad al espacio y encaja en todo tipo de proyectos de interior.



Floor lamp  
Lámpara de pie  
[Ref 5438](#) NMT

Table lamp  
Lámpara de mesa  
[Ref 4438](#) BMT

Wall lamp  
Lámpara de pared  
[Ref 1435](#) NMT

Suspension lamp  
Lámpara de suspensión  
[Ref 6987 - G](#) BMT

Floor lamp / Lámpara de pie

Ref 5438

LED 1 x 11W **A+** 



Wall lamp / Pared

Ref 1435

LED 1 x G9 4W **A+** 



Suspension lamps / Lámparas de suspensión

Ref 6987-G

LED 1 x 11W **A+** 



Ref 6987-P

LED 1 x 7W **A+** 



Table lamp / Lámpara de mesa

Ref 4438

LED 1 x G9 4W **A+** 

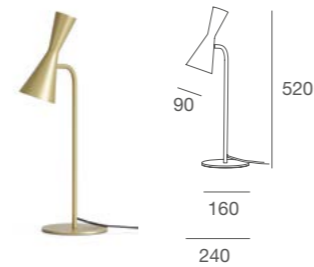

Tecnical data

Frame: painted iron metal.

Details: same coloured inside and outside. Table and floor lamps: black PVC cable for coloured metal and transparent for white metal. Textile cable for suspension lamps.

Recommended Bulb: E-27 7W or 11W LED (not included). G9 4W 3000K. 400 Lm 36° LED (included).

Important: the standard cable length is 1 metre, if you need special size please contact our Customer Support Department. We can value colour changes for projects with a minimum quantity.

Finishes Acabados

Metal Colour / Acabado Metal



Cable / Cable



Información técnica

Cuerpo: metal hierro pintado.

Detalles: acabado interior mismo color que exterior. Lámparas de mesa y pie: cable PVC negro en versiones de color y transparente para versión blanca. Cable textil para lámparas de suspensión.

Bombilla recomendada: E-27 7W o 11W LED (no incluida). G9 4W 3000K. 400 Lm 36° LED (incluida).

Importante: la longitud del cable estándar es de 1 metro, si desea una medida especial no dude en ponerse en contacto con nosotros. Se puede valorar cambios de color para proyectos con un mínimo de unidades.



Ceiling lamp

Suspensión

Ref 6987-G NMT



# LITE

2014 by Massmi

Spotlights have traditionally been used in markets, cafes, and bars. "Lite" embraces this characteristic functionality and simplicity. Extremely popular in retro decor, "Lite" also works well in Nordic or rustic settings.

La lámpara de foco se la reconoce tradicionalmente en mercados, tabernas y cafeterías. Lite es un reconocimiento a esa funcionalidad y simplicidad tan característica. Hoy muy presente en estilos retroindustrial, también encaja a la perfección en espacios sacandi o rústicos.



Suspension lamps

Lámparas de suspensión

[Ref 6974 TE](#)

[Ref 6982 TE](#)

[Ref 6976 TE](#)

[Ref 6973 TE](#)



Suspension lamps  
Lámparas de suspensión  
Ref 6982 CO Ref 6976 NMT Ref 6974 D

Suspension lamps / Lámparas de suspensión

Ref 6973

LED 1 x 11W A+



Ref 6974

LED 1 x 11W A+

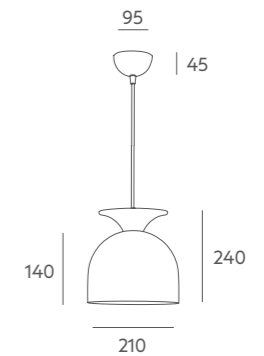

Ref 6976

LED 1 x 11W A+

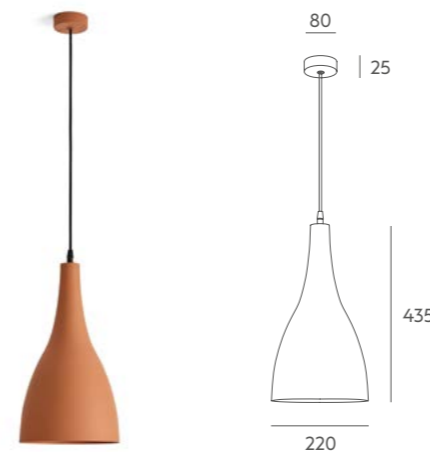

Ref 6982

1 x 40W A+

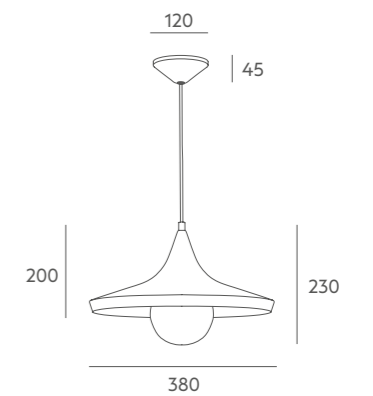

Tecnical data

Frame: painted iron metal.

Details: same coloured inside and outside. Black or white textile cable.

Recommended Bulb: E-27 11W LED (not included).  
Ref 6982 E-27 40W Nostalgic Edison bulb (included).

Important: the standard cable length is 1 metre, if you need special size please contact our Customer Support Department. We can value colour changes for projects with a minimum quantity.

Finishes Acabados

Metal Colour / Acabado Metal



Cable / Cable

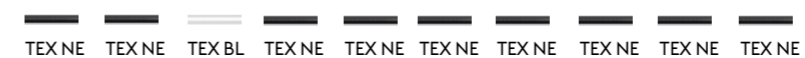

Información técnica

Cuerpo: metal hierro pintado.

Detalles: acabado interior mismo color que exterior. Cable textil negro o blanco.

Bombilla recomendada: E-27 11W LED (no incluida).  
Ref 6982 E-27 40W Nostalgic Edison bulb (incluida).

Importante: la longitud del cable estándar es de 1 metro, si desea una medida especial no dude en ponerse en contacto con nosotros. Se puede valorar cambios de color para proyectos con un mínimo de unidades.



# BERKA

2016 by Massmi

The Berka collection is a versatile lamp who fits perfectly in any kind of interior projects. The cone-shaped shade has a beechwood finial to lend a contemporary air to these simple, elegant fixtures.

La colección Berka en sus diferentes versiones encaja a la perfección en todo tipo de proyectos de interior. Su marcada pantalla cónica está terminada con una pieza de madera de haya torneada que le confiere una estética muy contemporánea, sencilla y elegante.

MASSMI +MI



Suspensión lamps  
Lámparas de suspensión  
[Ref 6983-G AZ / BMT / VE](#)

[Ref 6983 GR](#)

Table lamp  
Lámpara de mesa  
[Ref 4433 NMT](#)

Floor lamp  
Lámpara de pie  
[Ref 5433 TE](#)

SINCE 1942



Wall lamp  
Lámpara de pared  
Ref 1433 BMT

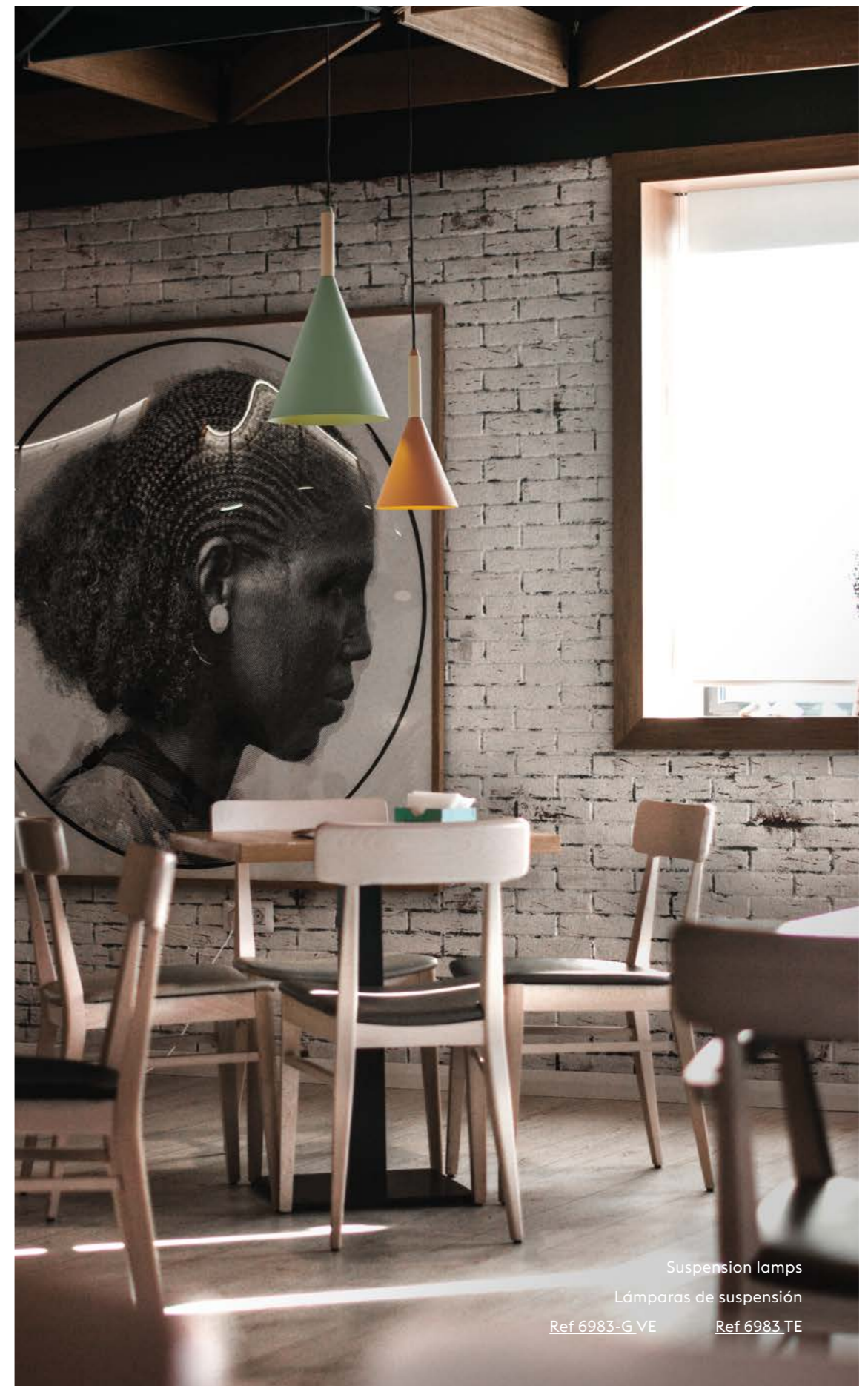

Suspension lamps  
Lámparas de suspensión  
Ref 6983-G.VE Ref 6983.TE



Floor lamp / Lámpara de pie

Ref 5433

LED 1 x 11W **A+** 

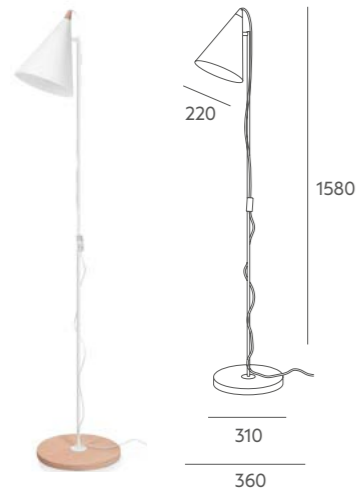

Wall lamp / Lámpara de pared

Ref 1433

LED 1 x 7W **A+** 



Tecnical data

Frame: painted or coated iron metal. Wooden support.

Details: same coloured inside and outside. Table and floor lamps: black and golden finishes with black PVC cable, white finish with transparent PVC cable. Textile wire for suspension lamps.

Recommended Bulb: E-27 7W or 11W LED (not included).

Important: the standard cable length is 1 metre, if you need special size please contact our Customer Support Department. We can value colour changes for projects with a minimum quantity.

Finishes Acabados

Metal Colour / Acabado Metal



Cable / Cable



Suspension lamps / Lámparas de suspensión

Ref 6983 G

LED 1 x 11W **A+** 



Ref 6983 P

LED 1 x 7W **A+** 



Table lamp / Lámpara de mesa

Ref 4433

LED 1 x 7W **A+** 

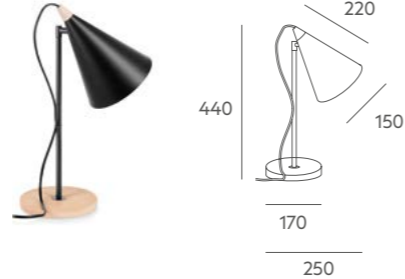

Información técnica

Cuerpo: metal hierro pintado o bañado. Soporte de madera acabado haya.

Detalles: acabado interior mismo color que exterior. Cable PVC negro en versiones dorado y negro y transparente en versión blanco para lamparas de mesa y pie. Cable textil para lámparas de suspensión.

Bombilla recomendada: E-27 7W o 11W LED (no incluida).

Importante: la longitud del cable estándar es de 1 metro, si desea una medida especial no dude en ponerse en contacto con nosotros. Se puede valorar cambios de color para proyectos con un mínimo de unidades.

Wood / Madera



Suspension lamp  
Lámpara de suspensión  
Ref 6983 GA HA-NE

# GARLAND

2015 by Massmi

Garland is a homage to the bare incandescent bulb aesthetic, which has been there from the very beginning. Stripped of unnecessary decoration and supported by a simple tubular structure, Garland becomes the star of the show in whatever decor it is used.

Garland es un homenaje a esa estética de la bombilla incandescente que tantos y tantos años nos ha acompañado. Desnuda y apoyada en una simple estructura tubular en distintos acabados pasa a ser la gran protagonista de la decoración.

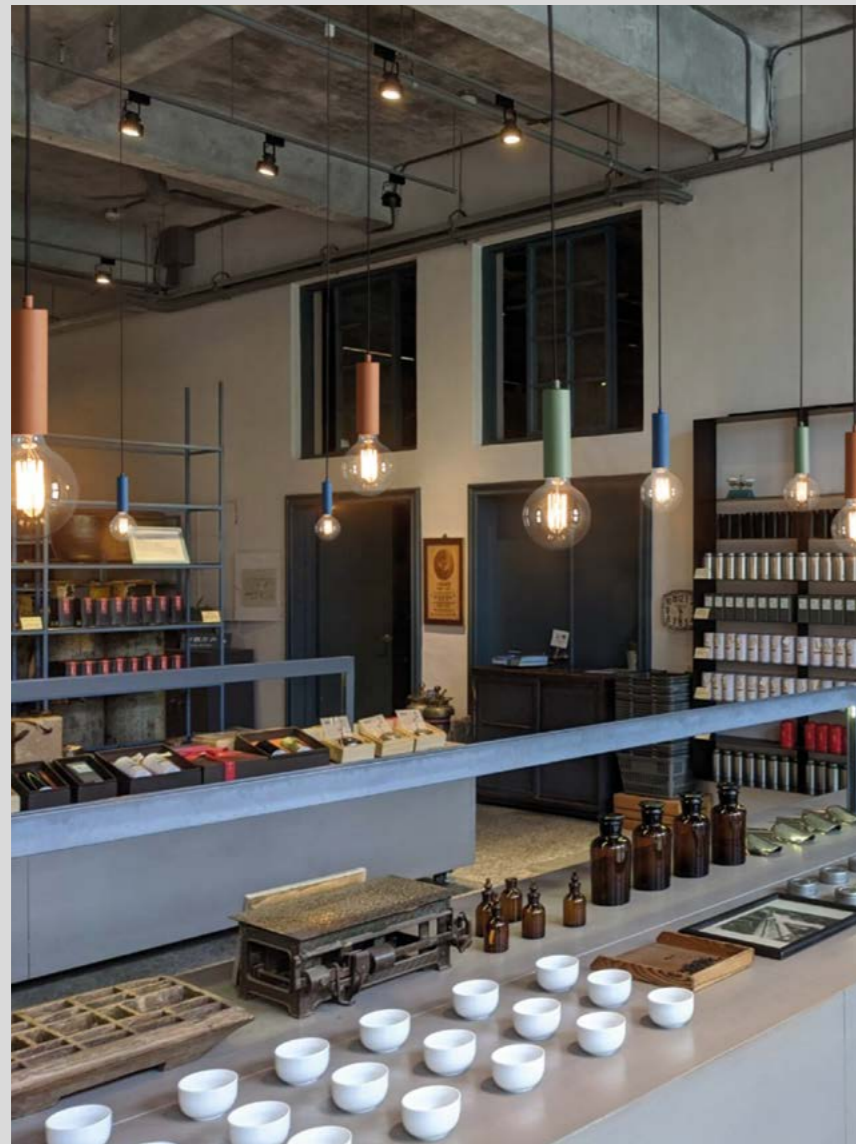

Suspension lamps  
Lámparas de suspensión  
Ref 6981 AZ / TE / VE



Suspension lamp  
Lámpara de suspensión  
Ref 6980 VE





Suspension lamp  
Lámpara de suspensión  
Ref 6979 BMT

Suspension lamps / Lámparas de suspensión

Ref 6980

4 x 40W **A+**

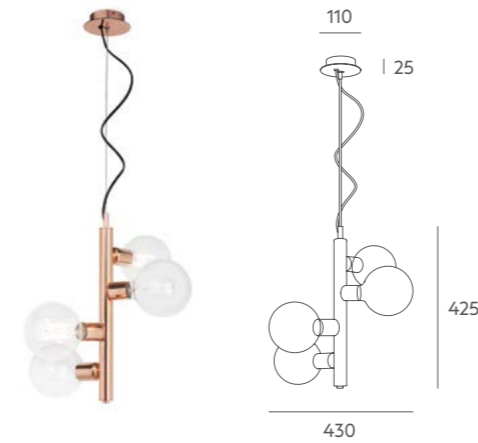

Ref 6979

3 x 40W **A+**

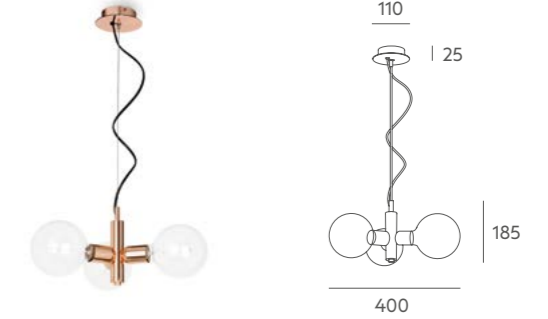

Ref 6981

1 x 40W **A+**

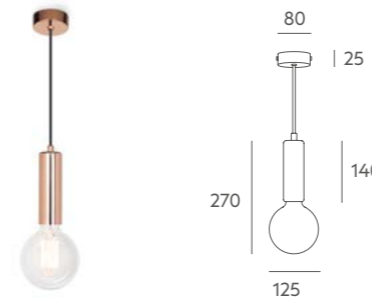

Table lamp / Lámpara de mesa

Ref 4419

1 x 40W **A+**



Tecnical data

Frame: painted or coated iron metal.

Details: black or white textil cable [Ref 6981](#). PVC cable [Ref 6979](#) [Ref 6980](#) [Ref 4419](#)

Recommended Bulb: E-27 40W Nostalgic Edison bulb (included).

Important: the standard cable length is 1 metre, if you need special size please contact our Customer Support Department. We can value colour changes for projects with a minimum quantity.

Finishes Acabados

Metal Colour / Acabado Metal



PVC wire / Cable PVC [Ref 6979](#) [Ref 6980](#)

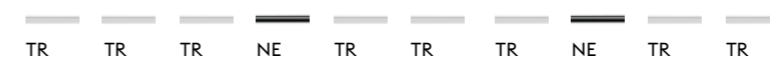

Textil wire / Cable textil [Ref 6981](#)



Información técnica

Cuerpo: metal hierro pintado o bañado.

Detalles: cable textil negro o blanco [Ref 6981](#). Cable PVC [Ref 6979](#) [Ref 6980](#) [Ref 4419](#)

Bombilla recomendada: E-27 40W Nostalgic Edison bulb (incluida).

Importante: la longitud del cable estándar es de 1 metro, si desea una medida especial no dude en ponerse en contacto con nosotros. Se puede valorar cambios de color para proyectos con un mínimo de unidades.



# POPPOL

2016 by Massmi

With two lampshade shapes and six colors which increase the utility of these simple dome-shaped, Poppol pendant lamps permit numerous possibilities for combinations. The beechwood accents heighten its Nordic styling.

Poppol se presta al juego compositivo de lámparas de suspensión con dos formatos de pantallas y seis colores que multiplican la utilidad de estas sencillas cúpulas luminosas. Su estilo nórdico lo acentúa el remate torneado en madera de haya.

MASSMI +MI



SINCE 1942

Lámparas de suspensión  
Suspensión lamps

[Ref 6985](#) TE / VE / BMT

[Ref 6984](#) GR / AZ / NMT

Suspension lamps / Lámparas de suspensión

Ref 6984

LED 1 x 11W **A+**

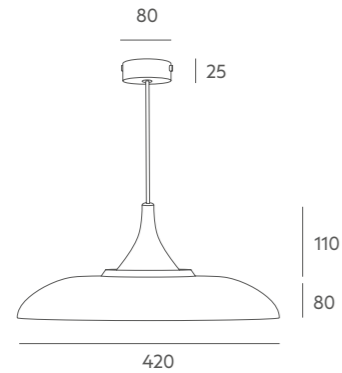

Ref 6985

LED 1 x 11W **A+**

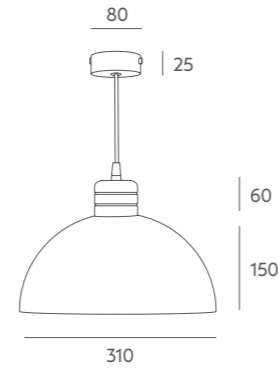

Tecnical data

Frame: painted iron metal. Beech wood holder.

Details: same coloured inside and outside. Textile cable.

Recommended Bulb: E-27 11W LED (not included).

Important: the standard cable length is 1 metre, if you need special size please contact our Customer Support Department. We can value colour changes for projects with a minimum quantity.

Finishes Acabados

Metal Colour / Acabado Metal



Cable / Cable



Información técnica

Cuerpo: metal hierro pintado. Soporte de madera acabado haya.

Detalles: acabo interior mismo color que exterior. Cable textil.

Bombilla recomendada: E-27 11W LED (no incluida).

Importante: la longitud del cable estándar es de 1 metro. Se puede valorar cambios de color para proyectos con un mínimo de unidades. Para cualquiera de estas opciones, no duden en consultarnos.

Wood / Madera



Lámpara de suspensión  
Suspension lamp  
Ref 6985\_VE

# BUBLE

Design 1970

"Buble" is 2008 version of our original 1970s design. A modern lamp with a simple tree-shaped design, "Buble" has a tubular base, available in chrome or copper finishes and fitted with opal glass spheres instead of traditional lampshades. This reedition of the Sixties piece is one of the oldest lamp in our catalogue and it fits to numerous settings.

Buble fue reeditada en el 2008, un clásico de nuestro catálogo creado en 1970. Gracias a su diseño arbolado que le confiere dinamismo a la esfera y su simplicidad, Buble es una pieza atemporal. Esta reedición de los años 70 es una de las más antiguas de nuestro catálogo y sin duda un básico en proyectos en cualquiera de sus versiones.



Suspension lamp  
Lámpara de suspensión  
Ref 6140 AZ

Ref 6139 CO  
Suspension lamp  
Lámpara de suspensión



BUBLE COLLECTION

Suspension lamps / Lámparas de suspensión

Ref 6138

LED 3 x 7W A+

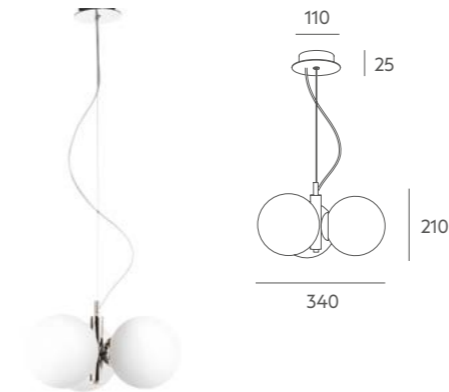

Ref 6139

LED 4 x 7W A+

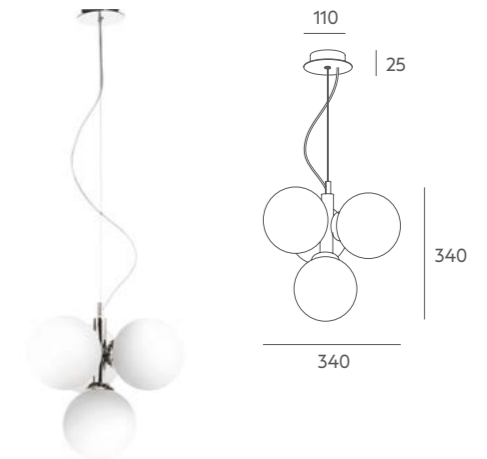

Ref 6140

LED 4 x 7W A+

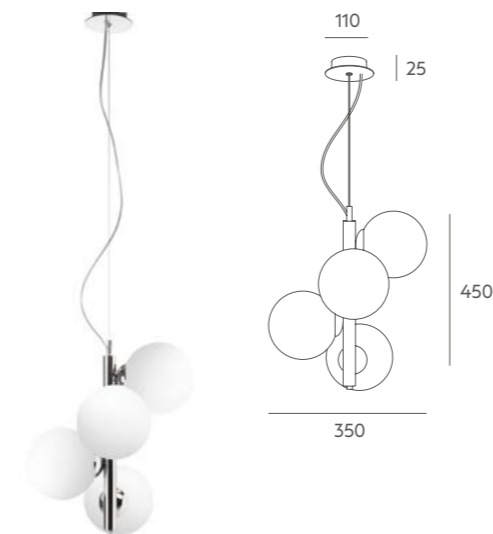

Tecnical data

Frame: painted or coated iron metal.

Details: steel cable + transparent PVC cable. Opal matte clip system glass

Recommended Bulb: E-14 7W LED (not included).

Important: the standard cable length is 1 metre, if you need special size please contact our Customer Support Department. We can value colour changes for projects with a minimum quantity.

Finishes Acabados

Metal Colour / Acabado Metal



Glass / Cristal



Información técnica

Cuerpo: metal hierro pintado o bañado.

Detalles: cable de acero + transparente PVC. Tulipas opal mate cogida con pinzas.

Bombilla recomendada: E-14 7W LED (no incluida).

Importante: la longitud del cable estándar es de 1 metro, si desea una medida especial no dude en ponerse en contacto con nosotros. Se puede valorar cambios de color para proyectos con un mínimo de unidades.



# AURA

2016 by Massmi

Aura has an undeniably sculptural look enhanced by the use of gold or silver leaf on the glass. The glass sphere is cut on the bottom to give off a more nuanced light. This lamp is perfect for creating compositions to add character to a large space, especially when hung in groups with each lamp at a different height. You may not want to switch the lights off ever again!

Aura destaca por un innegable aspecto escultórico acentuado por el uso del pan de oro o de plata sobre vidrio. Un globo de cristal con corte inferior para reflejar una luz llena de matices y efectos lumínicos. Ideal para crear composiciones que realcen una estancia espaciosa y a diferentes alturas para aumentar el efecto de la composición. ¡A partir de ahora no querrás apagar la luz de casa!

MASSMI + MI



Detail silver leaf  
Detalle pan de plata

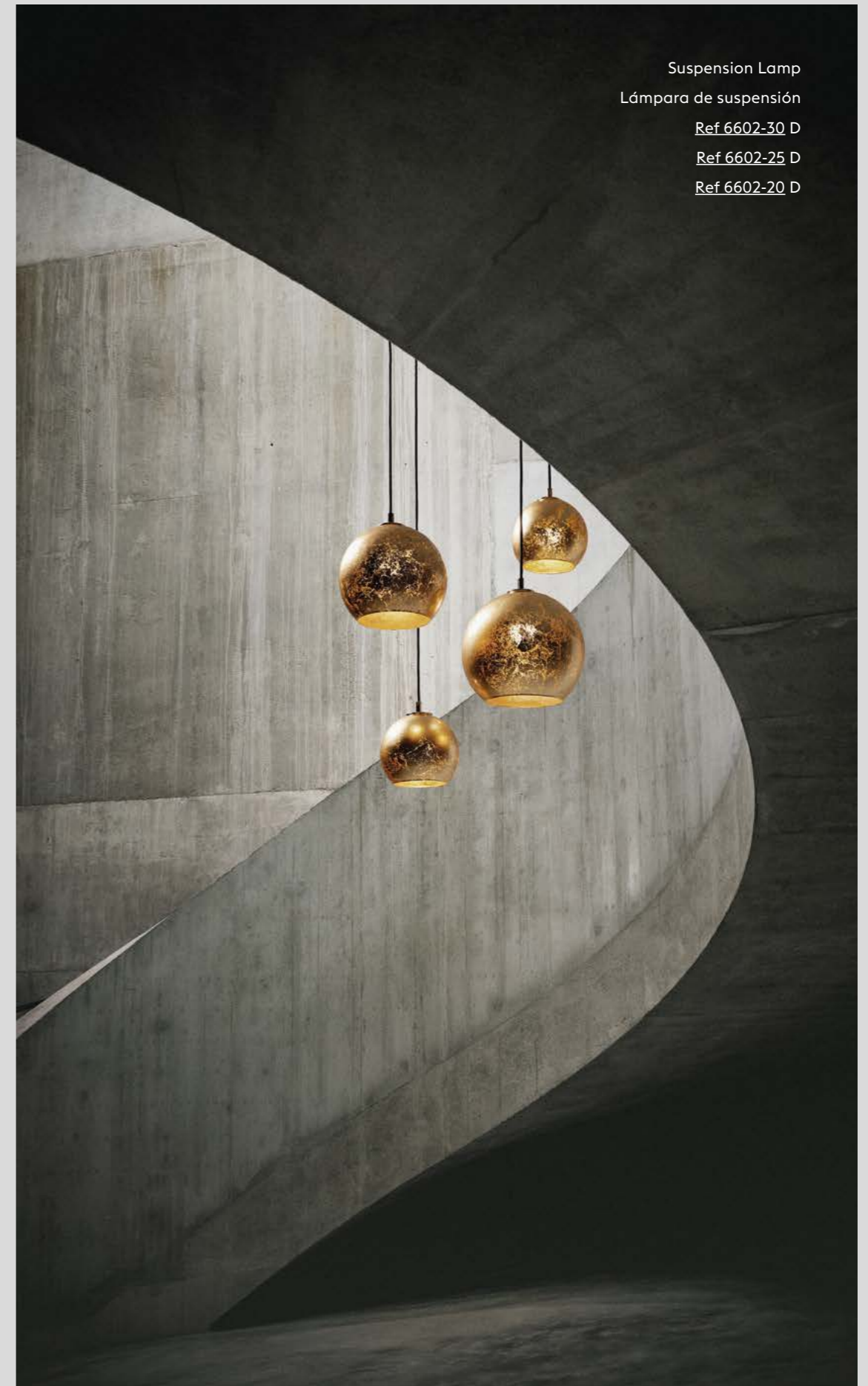

Suspension Lamp  
Lámpara de suspensión  
Ref 6602-30 D  
Ref 6602-25 D  
Ref 6602-20 D

SINCE 1942



Suspension lamps / Lámparas de Suspensión

Ref 6602-30

LED 1x11W **A+**

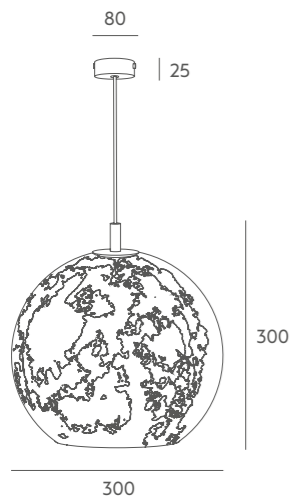

Ref 6602-25

LED 1x11W **A+**

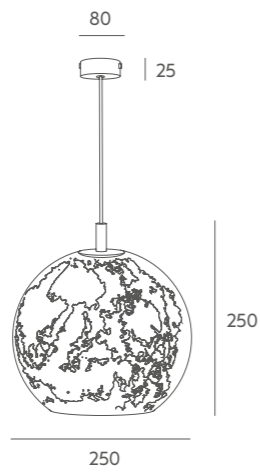

Ref 6602-20

LED 1x11W **A+**

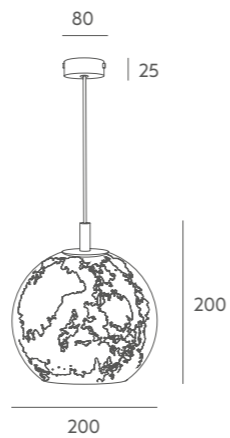

Tecnical data

Frame: chromed or gold iron metal.

Details: decoration with gold or silver leaf. Black textile cable.

Recommended Bulb: E-27 11W (not included).

Important: the standard cable length is 1 metre, if you need special size please contact our Customer Support Department.

Finishes Acabados

Metal Colour / Acabado Metal



CR D

Glass / Cristal



D PL

Información técnica

Cuerpo: metal hierro acabado en cromo u oro brillo.

Detalles: decorado pan de oro o pan de plata. Cable textil color negro.

Bombilla recomendada: E-27 11W (no incluida).

Importante: la longitud del cable estándar es de 1 metro, si desea una medida especial no dude en ponerse en contacto con nosotros.



Suspension lamps  
Lámparas de suspensión  
Ref 6602-25 D  
Ref 6602-30 D

# CIRCA

Design 1976

In the Circa collection, the glass provides the mood lighting. Its silhouette and volume lend this flushmount lamp an air of refinement, whether it is installed on the ceiling or the wall. Made of triplex opal glass, Circa lamps give off a subtle, suggestive light. Available in two shapes and three sizes, the Circa collection allows for a great variety of applications and combinations, either in private homes or larger settings, and is perhaps our most versatile collection.

En Circa todo el vidrio se convierte en emisor de luz ambiente. Su perfil y su volumen, nos recuerda que estamos ante un plafón ya sea colocado en techo o en pared de presencia, discreta y refinada. Circa está fabricada en cristal Triplex opalizado y el efecto de luz tamizada es muy sugerente. Sus seis versiones permiten gran variedad de aplicaciones y combinaciones, diseñada para ambientes decorativos, instalaciones y hogares, se trata de un producto muy versátil.



Ref 3459-25  
Ref 3459-20

Ref 3459-30

Ceiling lamps  
Plafones  
Ref 3460-30  
Ref 3460-25  
Ref 3460-20

## CIRCA COLLECTION

Ceiling lamps / Plafones

Ref 3460-30

LED 2 x 7W **A+**

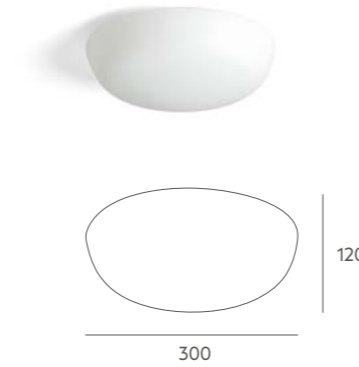

Ref 3460-25

LED 1 x 7W **A+**

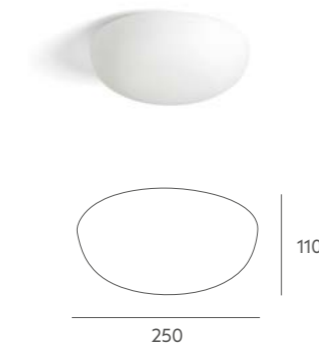

Ref 3460-20

LED 1 x 7W **A+**

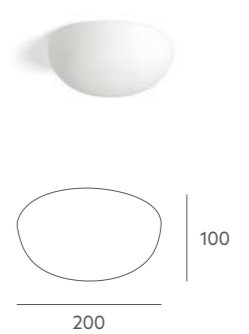

Ref 3459-30

LED 2 x 7W **A+**

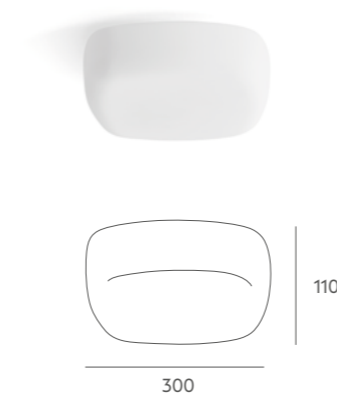

Ref 3459-25

LED 1 x 7W **A+**

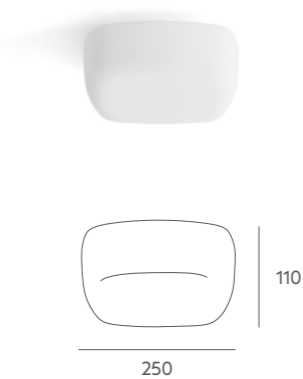

Ref 3459-20

LED 1 x 7W **A+**

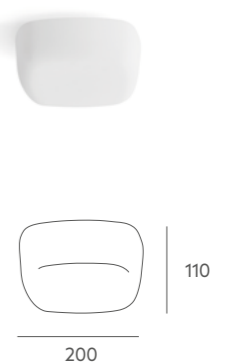

**Tecnical data**

Frame: zink support  
Details: mate opal glass. Stone socket. System to hold the glass by using gyrotory clips.  
Recommended Bulb: E-27 7W LED (not included).

**Finishes Acabados**

Glass / Cristal



**Información técnica**

Cuerpo: soporte zincado.  
Detalles: cristal opal mate. Portalámparas de piedra. Cogida de soporte de cristal mediante pestañas giratorias.  
Bombilla recomendada: E-27 7W LED (no incluida).



# PURA

2018 by Nacho Timón

Technical and decorative lamp inspired on the Mid Century. Perfect to be used in different kind of spaces offering a perfect general lighting. Very adequate for contract spaces even large areas. It supports bulbs with different powers and projection angles; it's available in two sizes and several colour combinations.

Lámpara técnica a la vez que decorativa cuya esencia se inspira en el Mid Century. Pieza ideal para instalarse en multitud de espacios ofreciendo una perfecta iluminación general. Adecuada en espacios hosteleros, comerciales y grandes superficies. Admite bombillas de varias potencias y ángulos de proyección; y se fabrica en dos tamaños con varias combinaciones de color.



Ceiling lamps  
Plafones  
[Ref 3422-P BL-D](#) [Ref 3422-G NE-D](#)



Ceiling lamps / Plafones  
 Ref 3422-P BL-D Ref 3422-G NE-D

Ceiling lamps / Plafones

Ref 3422-P

LED 1 x 15W **A+**

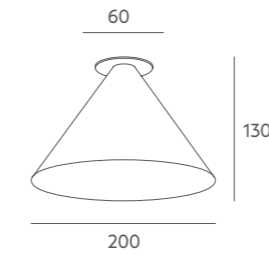

Ref 3422-G

LED 1 x 15W **A+**

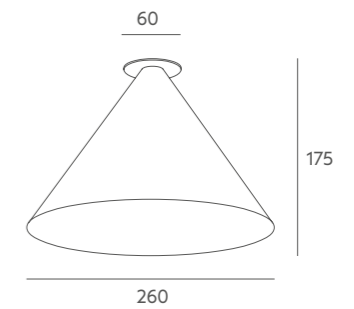

Tecnical data

Frame: painted iron metal in one or two colours.

Details: clip support.

Recommended Bulb: GU10 15W LED. 4000K 1300 Lm 36°. (included)

Important: we can evaluate to change painting colour for projects with a minimum quantity of pieces, please check with us.

Finishes / Acabados

Metal Colour / Acabado Metal



Información técnica

Cuerpo: metal hierro pintado monocolor o bicolor.

Detalles: soporte con pinzas, para techos con talla.

Bombilla recomendada: GU10 15W LED. 4000K 1300 Lm 36°. (incluida)

Importante: se puede valorar cambios en la pintura para proyectos con un mínimo de unidades, no duden en consultarnos.



# PETIT

2016 by Massmi

Stylized table lamps, Their small format makes them perfect for creating a warm, cozy nook in any space.

Altas y estilizadas, Pensadas para acompañar en espacios donde queramos aportar un punto de calidez. Se adaptan con facilidad a cualquier espacio.

MASSMI +MI



Color details  
Detalles color

- Table lamps
- Lámparas de pie
- [Ref 4434 AZ BL](#)
- [Ref 4435 BMT BL](#)
- [Ref 4435 TE BL](#)
- [Ref 4434 NMT NE](#)
- [Ref 4435 NMT NE](#)

- Floor lamps
- Lámparas de pie
- [Ref 5435 BMT BL](#)
- [Ref 5435 NMT NE](#)



SINCE 1942

Table lamps / Lámparas de mesa

Ref 4435

LED 1 x 11W 



Ref 4434

LED 1 x 11W 

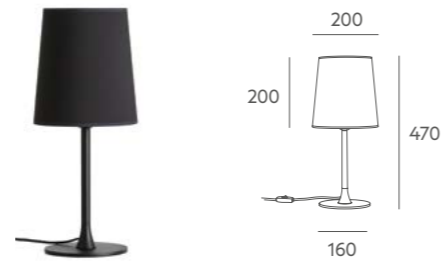

Floor lamp / Lámpara de pie

Ref 5435

LED 1 x 11W 



Tecnical data

Frame: painted iron metal.

Details: translucent cotton shade. PVC cable.

Recommended Bulb: E-27 11W LED (not included).

Important: we can value colour changes for projects with a minimum quantity.

Información técnica

Cuerpo: metal hierro pintado.

Detalles: pantalla de tela de algodón traslúcido. Cable PVC.

Bombilla recomendada: E-27 11W LED (no incluida).

Importante: se puede valorar cambios de color para proyectos con un mínimo de unidades.

Finishes Acabados

Metal Colour / Acabado Metal



Cable / Cable



Shade / Pantalla

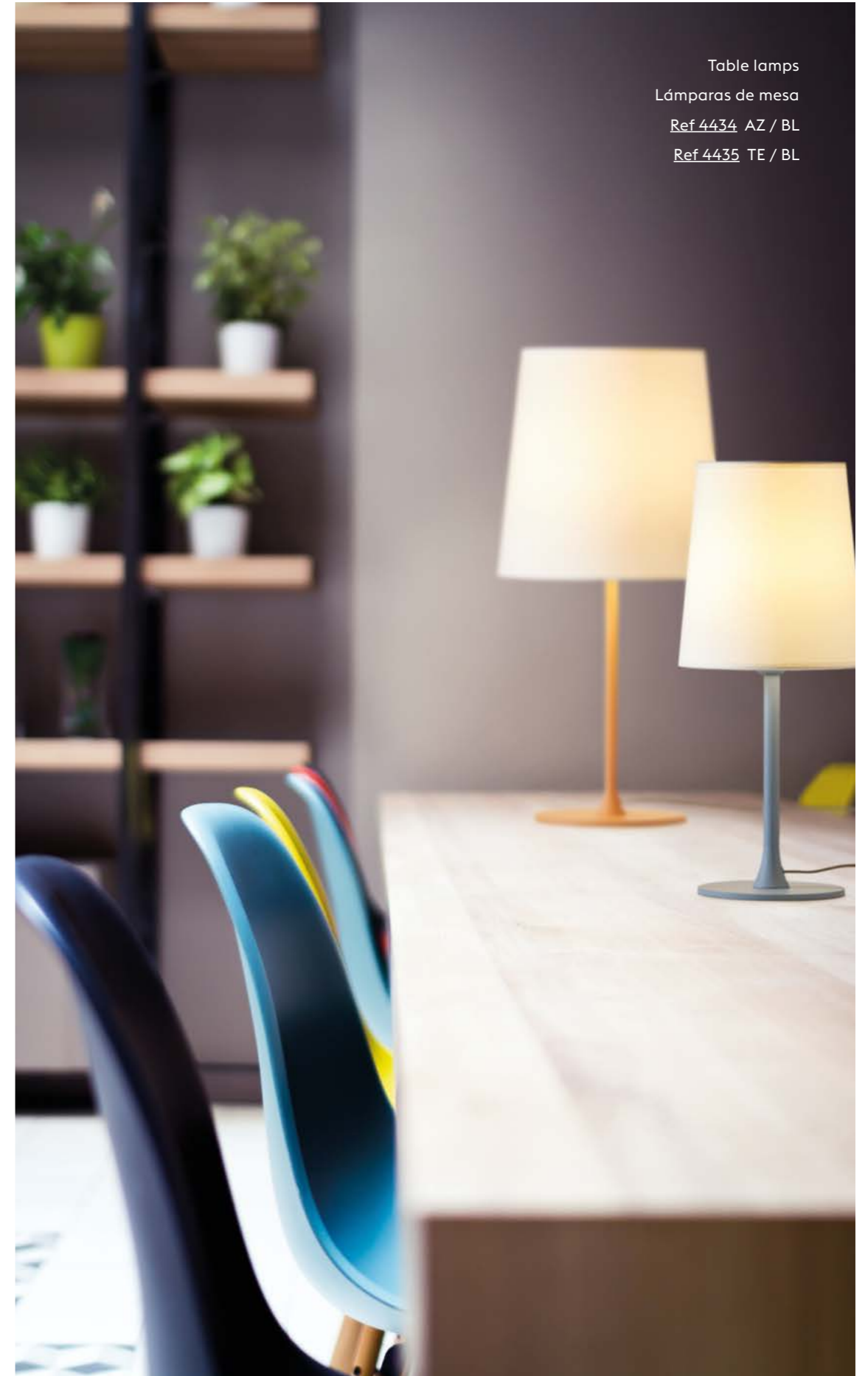

Table lamps  
Lámparas de mesa  
Ref 4434 AZ / BL  
Ref 4435 TE / BL

# NAAF

2016 by Massmi

Naaf has a minimal design, a simple cotton shade under a light metal structure. It's perfect to create discreet and comfortable settings. Available in two colors, white and black.

Naaf posee un diseño minimalista, una sencilla pantalla de algodón apoyada sobre una fina estructura metálica. Es perfecta para crear ambientes discretos y confortables. Se presenta en dos colores, blanco o negro.

Project by Alberto García interior design / Proyecto de Alberto García diseño interior



Suspension lamp  
Lámpara de suspensión  
Ref 6857 BMT BL

## NAAF COLLECTION

Suspension lamp / Lámpara de suspensión

Ref 6857

LED 1 x 11W **A+**



Floor lamp / Lámpara de pie

Ref 5457

LED 1 x 11W **A+**



Table lamps / Lámparas de mesa

Ref 4458

LED 1 x 11W **A+**



Ref 4457

LED 1 x 11W **A+**



Tecnical data

Frame: painted iron metal.

Details: translucent cotton shade. PVC cable.

Recommended Bulb: E-27 11W LED (not included).

Important: the standard cable length is 1 metre, if you need special size please contact our Customer Support Department.

Finishes Acabados

Metal Colour / Acabado Metal



Cable / Cable



Shade / Pantalla



Información técnica

Cuerpo: metal hierro pintado.

Detalles: tela de algodón traslúcido. Cable PVC.

Bombilla recomendada: E-27 11W LED (no incluida).

Importante: la longitud del cable estándar es de 1 metro, si desea una medida especial no dude en ponerse en contacto con nosotros.



# DLED

2009 by Massmi

Airy, discreet and flexible family of wall lamps to focus light to the desired place (maximum flexion of 90°) without glare. The flex is made of covered iron to guarantee its stability and long life with daily use. Base shapes can be square or round, depending on the particular client's need. Dled is a perfect fixture to use in private or public settings.

Familia de apliques de aspecto ligero, discreto y flexible, lo que permiten focalizar la luz hacia el lugar deseado (flexión máxima 90°) sin producir deslumbramientos. El tubo flexible es de hierro revestido que garantiza su rigidez y una mayor durabilidad. Las bases de este aplique pueden ser de formato cuadrado o redondo según sean las necesidades del usuario. Apto tanto para el ámbito residencial como para el contract.

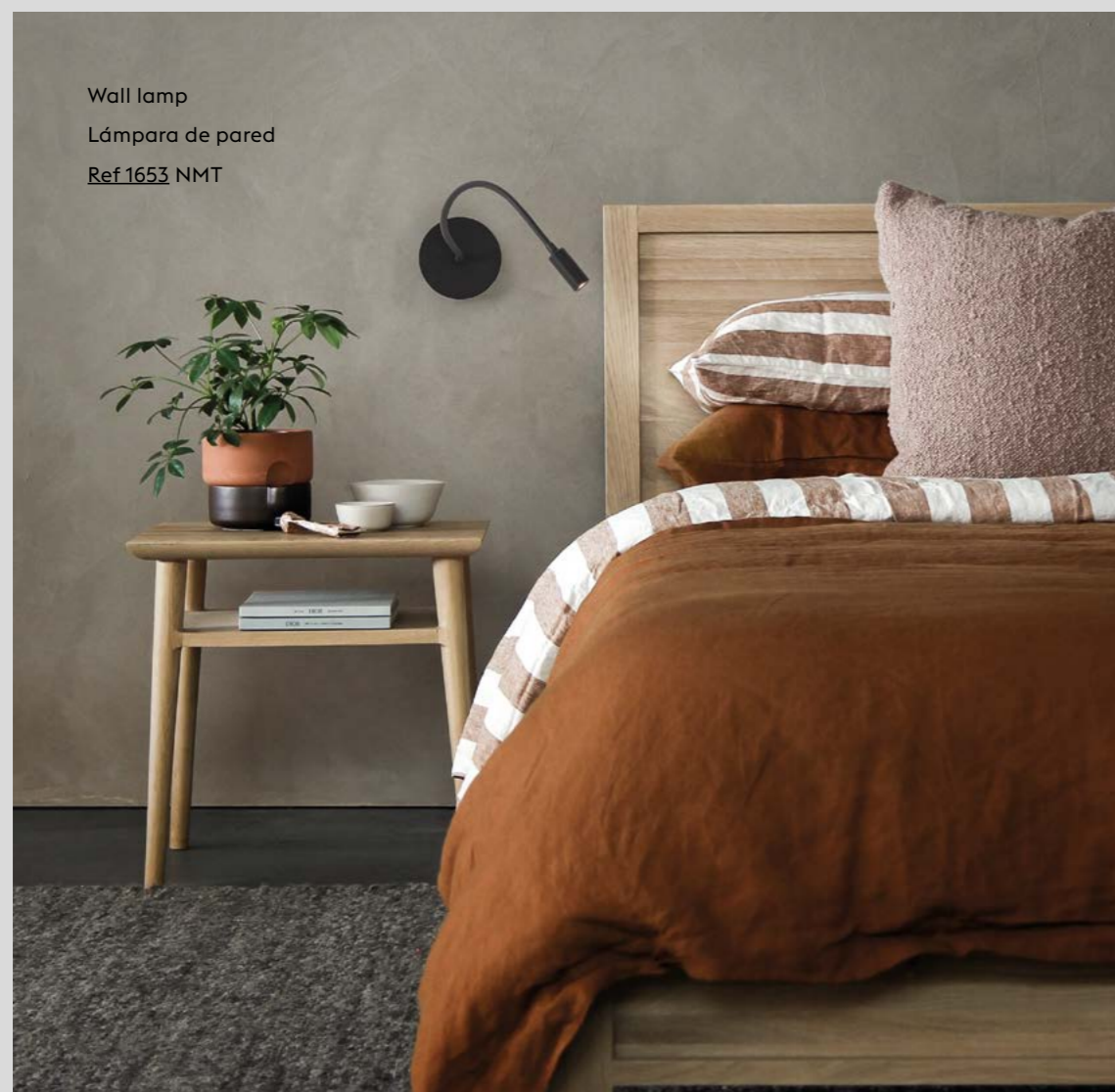

Wall lamp  
Lámpara de pared  
Ref 1653 NMT

MASSMI + MI

SINCE 1942

## DLED COLLECTION

Wall lamps / Lámparas de pared

Ref 1652

LED 1 x 1,4W **A++**

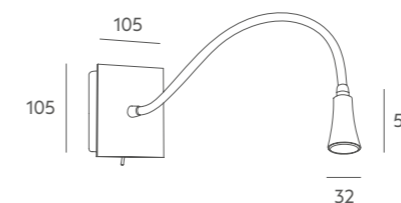

Flexible arm / Brazo flexible 380

Ref 1653

LED 1 x 1,4W **A++**

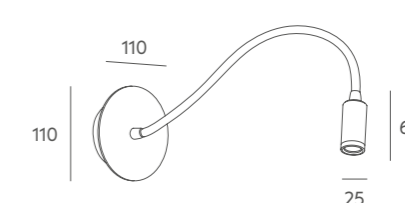

Flexible arm / Brazo flexible 380

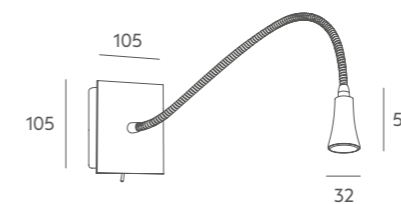

Flexible arm / Brazo flexible 380

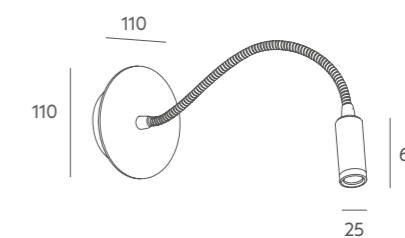

Flexible arm / Brazo flexible 380

### Tecnical data

Frame: satin nickel or painted iron metal.

Details: metal switch. Flexible arms.

Recommended Bulb: bulb + transformer included 1,4W LED. 6000K.

### Finishes Acabados

Metal Colour / Acabado Metal



Flexible arm / Brazo flexible

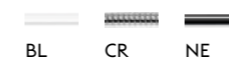

### Información técnica

Cuerpo: níquel satinado o metal hierro pintado.

Detalles: interruptor metálico. Brazos flexibles.

Bombilla recomendada: bombilla y transformador incluido: 1,4W LED. 6000K.





# SIMPLICITY

2009 by Massmi

Extensive lighting collection of suspensions, ceiling lamps, wall lamps and table lamps, giving the possibility to choose between several sizes, shapes, colors and finishes. Simplicity is a versatile basic piece easy to fit in different kind of ambiances and design styles.

Amplia gama de luminarias que incluye plafones, colgantes, lámparas de pared y sobremesas, ofreciendo la posibilidad de elegir entre múltiples tamaños, formas, colores y acabados. Simplicity es una pieza básica fácil de acomodar en diversos ambientes y estilos por su diseño versátil. Idónea para proyectos de instalaciones que ofrece la posibilidad de jugar con el color y los tamaños, creando así numerosas composiciones.



Suspension Lamp  
Lámpara de suspensión  
Ref 6920-100 BL

Suspension lamps / Lámparas de Suspensión

Ref 6920-100 Cotton / Algodón

Ref 6921-100 Pleated / Plisado

LED 5 x 7W **A+**

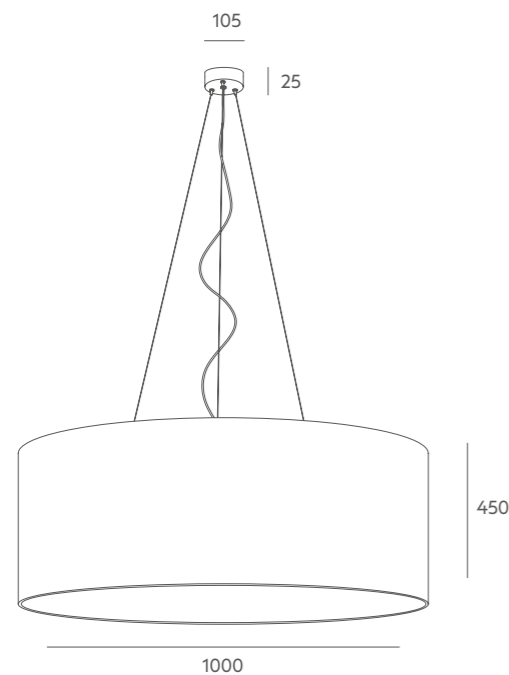

Ref 6920-60-70 Cotton / Algodón

Ref 6921-60-70 Pleated / Plisado

Ref 6961-60-70 Linen / Lino (min. 4uds)

Ref 6935-80 Lamitex / Lamitex (min. 4uds)

LED 3 x 11W **A+**

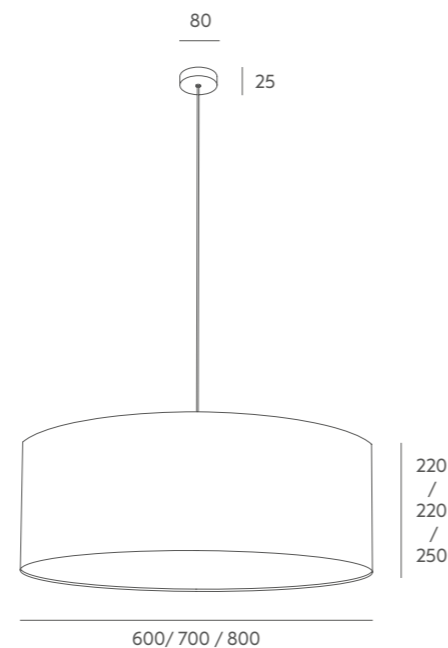

Ref 6920-50 Cotton / Algodón

Ref 6921-50 Pleated / Plisado

Ref 6961-50 Linen / Lino (min. 4uds)

Ref 6935-50 Lamitex / Lamitex (min. 4uds)

LED 2 x 11W **A+**



Tecnical data

Details: translucent cotton shade. White parchment diffuser. Black or transparent PVC cable. Ref 6920-100 Ref 6921-100 transparent PVC cable + steel cable and white parchment partial diffuser.

Recommended Bulb: E-27 7W or 11W LED (not included).

Important: the standard cable length is 1 metre, if you need special size please contact our Customer Support Department. We can evaluate to change lampshade material for projects with a minimum quantity of pieces, please check with us.

Finishes Acabados

Metal Colour / Acabado Metal

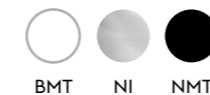

Shade / Pantalla



Shade / Pantalla (min. 4uds)

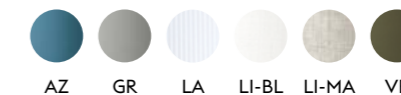

Cable / Cable

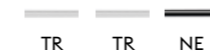

Ref 6920-35 Cotton / Algodón

Ref 6921-35 Pleated / Plisado

Ref 6961-35 Linen / Lino (min. 4uds)

Ref 6935-35 Lamitex / Lamitex (min. 4uds)

LED 1 x 11W **A+**

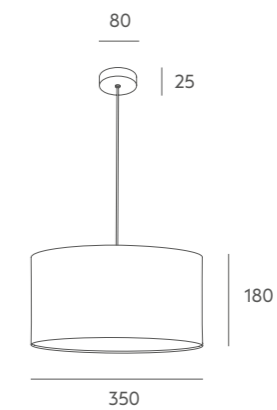

Información técnica

Detalles: pantalla de tela de algodón traslúcido. Difusor de pergamino blanco. Cable PVC negro o transparente. Ref 6920-100 Ref 6921-100 cable transparente + cable de acero y difusor pergamino blanco parcial.

Bombilla recomendada: E-27 7W o 11W LED (no incluida).

Importante: la longitud del cable estándar es de 1 metro, si desea una medida especial no dude en ponerse en contacto con nosotros. Se puede valorar cambios de tela para proyectos con un mínimo de unidades, no duden en consultarnos.



\* Metal finish will be as photo, otherwise black metal.

\* El acabado del metal será como foto, y en su defecto metal negro.



Suspension Lamp  
Lámpara de suspensión  
Ref 6921-70 PC NI

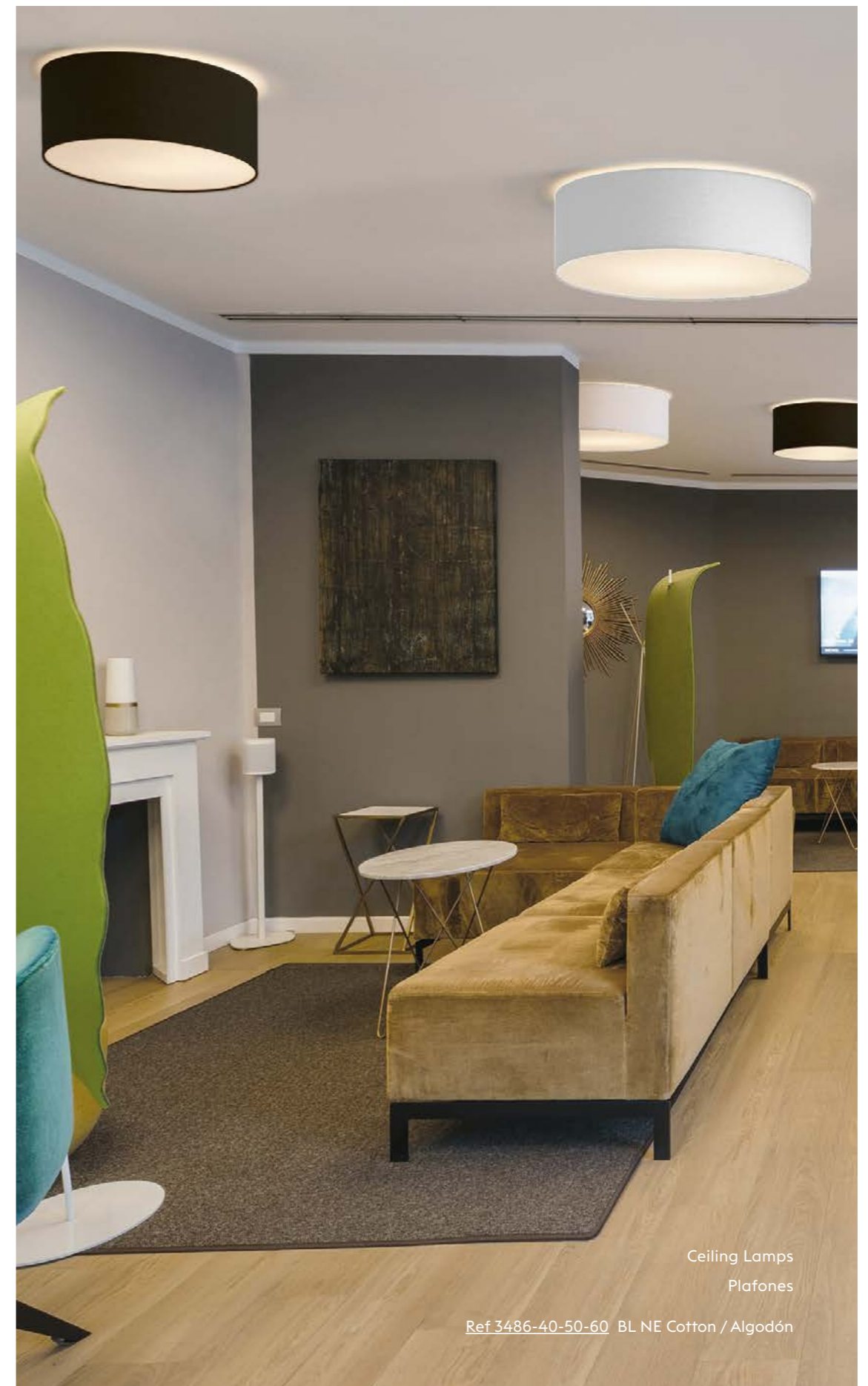

Ceiling Lamps  
Plafones

Ref 3486-40-50-60 BL NE Cotton / Algodón

Ceiling lamps / Plafones

Ref 3486-25 Cotton / Algodón

Ref 3465-25 Pleated / Plisado

Ref 3461-25 Linen / Lino (min. 4uds)

Ref 3490-25 Lamitex / Lamitex (min. 4uds)

LED 2 x 7W **A+**

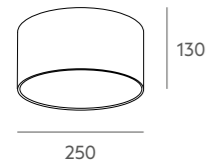

Ref 3486-40 Cotton / Algodón

Ref 3465-40 Pleated / Plisado

Ref 3461-40 Linen / Lino (min. 4uds)

LED 2 x 11W **A+**

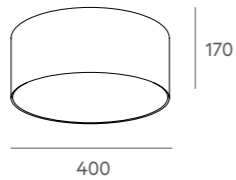

Ref 3486-50 Cotton / Algodón

Ref 3465-50 Pleated / Plisado

Ref 3461-50 Linen / Lino (min. 4uds)

LED 2 x 11W **A+**

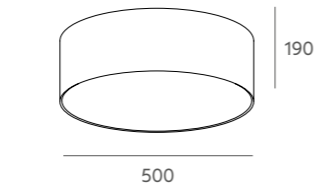

Ref 3486-60 Cotton / Algodón

Ref 3465-60 Pleated / Plisado

Ref 3461-60 Linen / Lino

LED 4 x 11W **A+**

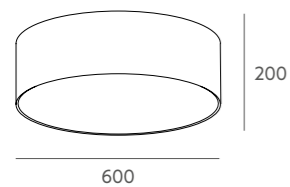

Ref 3486-70 Cotton / Algodón

Ref 3465-70 Pleated / Plisado

Ref 3461-70 Linen / Lino

LED 4 x 11W **A+**

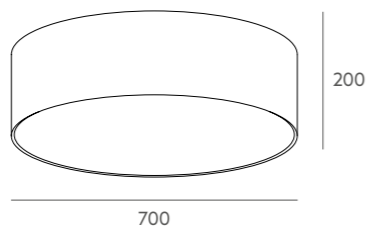

Ref 3489-50-60-70 Cotton / Algodón

Ref 3490-50-60-70 Lamitex / Lamitex (min. 4uds)

LED 2 x 11W / 4 x 11W **A+**

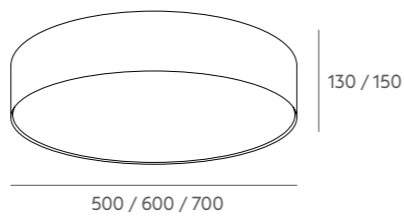

Tecnichal data

Details: Opaque cotton lampshade. White parchment diffuser. Stone socket. Magnet system.

Recommended Bulb: E-27 7W or 11W LED (not included).

Important: we can evaluate to change lampshade material for projects with a minimum quantity of pieces, please check with us.

Finishes Acabados

Shade / Pantalla



Shade / Pantalla (min. 4uds)



Información técnica

Detalles: pantalla de tela de algodón traslúcido. Difusor de pergamino blanco. Portalámparas de piedra. Sistema de sujeción de la pantalla con imanes.

Bombilla recomendada: E-27 7W o 11W LED (no incluida).

Importante: se puede valorar cambios de tela para proyectos con un mínimo de unidades, no duden en consultarnos.



Wall lamps / Lámparas de pared

Ref 1674 Cotton / Algodón

Ref 1673 Pleated / Plisado

Ref 1676 Linen / Lino (min. 4uds)

Ref 1675 Lamitex / Lamitex (min. 4uds)

LED 1 x 7W **A+**

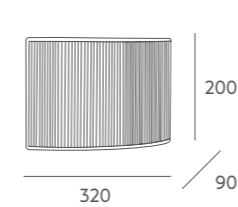

Ref 1656 Cotton / Algodón

Ref 1655 Pleated / Plisado

Ref 1657 Linen / Lino (min. 4uds)

LED 1 x 7W **A+**

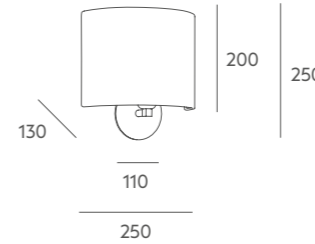

Ref 1654-25-30 Cotton / Algodón

LED 1 x 7W **A+**

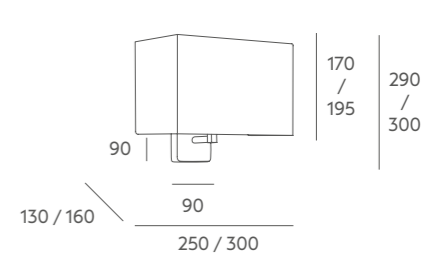
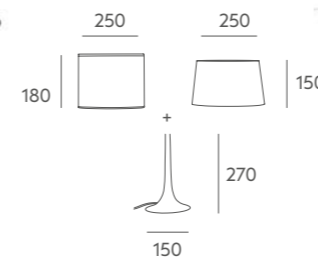

Table lamps / Lámparas de mesa

Ref 4364

LED 1 x 7W **A+**



Ref 4365

LED 1 x 7W **A+**



Ref 4366

LED 1 x 7W **A+**

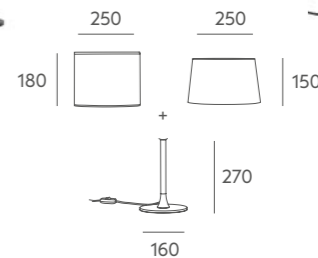

Ref 4367

LED 1 x 7W **A+**



Tecnichal data

Details: painted or coated iron metal. Translucent cotton shade. Black or transparent PVC cable according to version.

Recommended Bulb: E-27 7W LED (not included).

Important: we can evaluate to change lampshade material for projects with a minimum quantity of pieces, please check with us.

Finishes Acabados

Metal Colour / Acabado Metal



Cable / Cable

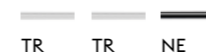

Shade / Pantalla



Shade / Pantalla (min. 4uds)



Información técnica

Detalles: metal hierro pintado o bañado. Pantalla de tela de algodón traslúcido. Cable PVC negro o transparente según versión.

Bombilla recomendada: E-27 7W LED (no incluida).

Importante: se puede valorar cambios de tela para proyectos con un mínimo de unidades, no duden en consultarnos.



# BLAIR

1998 by Massmi

We are specialized in comfort for home ambience since 1986 when we began to distribute in Spain ceiling fans. Our fans are synonym of a guaranteed quality in the best level after 35 years of experience. During these years we have orientated our enthusiasm and our culture of management to one objective: service to the customer. Is the reason why so many people trust on us and our fans belong to their life. The most important projects for housing include in their quality memories our fans in any of their rooms. A technology and a human team working at same time with enthusiasm to attend you.

Especialistas en confort ambiental para el hogar desde que en 1986 fuimos uno de los primeros en distribuir a nivel nacional, equipos de ventilación de techo, llevando el confort a miles de hogares. Nuestros equipos son sinónimo actualmente de calidad garantizada al mejor nivel, 35 años de experiencia nos avalan. Durante todos estos años hemos orientado nuestro entusiasmo y nuestra cultura empresarial a un sólo objetivo: la atención y el servicio al cliente. Una tecnología y un equipo humano funcionando al unísono con entusiasmo para atenderle.



Suspension lamp  
Lámpara de techo  
Ref 50997

## BLAIR COLLECTION

Fans / Ventiladores

Ref 50997

with light / con luz

LED 2 x 11W **A+**

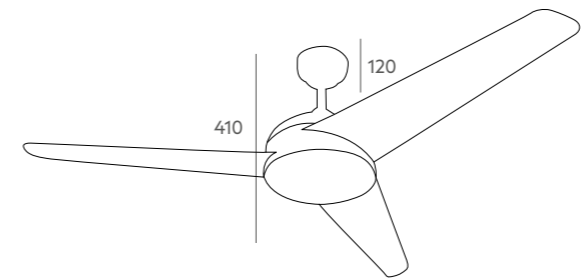

1320

Ref 50997 S

without light / sin luz

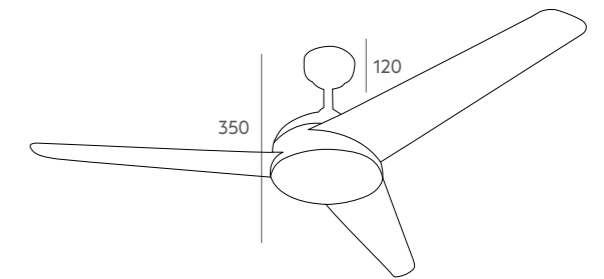

1320

### Tecnichal data

Frame: metal + wood.

Details: W / RPM · 55W / 200/189/123rpm

Recommended Bulb: 2 x 11W (not included).

Caracteristique: Weight 8kg / Ariflow 351m<sup>3</sup> / Engine AC V / Hz · 3 speeds



Remote control / Mando a distancia



Winter function / Función invierno



Noiselessn / Silencioso

### Finishes Acabados

Metal Colour / Acabado Metal



BL

Blades / Palas



BL

### Información técnica

Cuerpo: metal + madera.

Detalles: W / RPM · 55W / 200/189/123rpm

Bombilla recomendada: 2 x 11W (no incluida).

Características: Peso 8kg / Flujo de aire 351m<sup>3</sup> / Motor AC V / Hz · 3 velocidades



---

## THE MOST ECOLOGIC REFRIGERATION / REFRIGERACIÓN ECO

The consumption of electric energy is very low if we compare with other refrigeration systems. Its small motor doesn't damage the atmosphere, and its life is long, so it's produce a reduction of recycling problems.

One fan has 2 years guarantee, although its damage is difficult, with a minimum external cleaning we can maintain it all life. Fans work perfectly without using any product to lubricate them and this helps us to protect the environment.

El consumo de energía eléctrica es muy reducido si se compara con otros sistemas de refrigeración. Su pequeño motor no emite sustancia alguna a la atmósfera, y su vida útil es larga, lo que deriva en una notable reducción de problemas de reciclaje.

Un aparato de ventilación goza de una garantía de dos años, aunque raramente se averían y funcionan toda la vida con un mínimo mantenimiento de limpieza externa.

Funcionan perfectamente sin necesidad de lubricarlos con grasas o aceites, lo que ayuda a preservar el medio ambiente.

---

## LOW CONSUMPTION / BAJO CONSUMO

The consumption is minimal. A good ceiling fan who works at maximum speed doesn't consume the equivalence to one 100W bulb. There are some distinctives of a quality fan and one of them is the noiseless and no vibration if the installation is correctly done.

En relación a su eficiencia el consumo es mínimo. Un buen ventilador, funcionando a su máxima velocidad no llega a consumir el equivalente a una bombilla de 100W.

Hay muchas características que diferencian a un ventilador de calidad del resto, una de las más notables es la carencia de ruidos y vibraciones, si su instalación se ha realizado correctamente.

---

## FRESH AIR EFFECT / EFECTO "AIRE FRESCO"

A quality ceiling fan refrigerates one room producing an effect "fresh air" even without reducing the temperature. This effect "fresh air" makes we can feel refreshed reducing our corporal temperature about 3°C. If we are in a room with 30°C and we switch on a quality fan, the "fresh air" effect begins and makes we fell the temperature is 27°C.

Un ventilador de techo de calidad refrigera una habitación creando un efecto de "aire fresco", aún sin bajar la temperatura de la estancia. Este efecto "aire fresco" hace que nos sintamos refrigerados, acelerando el proceso de evaporación de la transpiración del cuerpo, bajando así la temperatura corporal hasta 3°C. Si nos encontramos en una habitación cuya temperatura es de 30°C y ponemos en funcionamiento un ventilador de calidad se crea un efecto "aire fresco" que hace que nos sintamos como si la temperatura fuese de 27°C.

---

## WINTER FUNCTION / FUNCIÓN INVIERNO

One quality ceiling fan can reduce the energy cost to heat a room about 10% if we use "winter fonction". The air of a warmed room is distributed in coats of different temperatures, the highest is the lightest, so the air in contact with the ceiling is hotter than the air in contact with the floor. A good fan can push down this air from the top till the rest of the room, where we need it. He mixes the different coats making similar the temperature in the room. This function can be activated using the winter switch.

The blades change the sense as the hands of the clock and it's make the fan absorbs the fresh air on the floor and push the hot one in order it goes down. This situation doesn't cause any sensation of air stream.

Un ventilador de calidad, en su "posición invierno" puede bajar el coste de la energía que consumimos para calentar una habitación hasta un10%. El aire de una habitación que ha sido calentada se distribuye en capas sucesivas de distintas temperaturas, siendo la temperatura más alta la más ligera y la que asciende situándose en las capas más altas, es decir, el aire que está en contacto con el techo es más caliente y el del suelo más frío. Un buen ventilador puede hacer descender este aire cálido atrapado en el techo hacia la parte baja de la habitación, donde más se necesita, mezclando las capas de aire y homogeneizando la temperatura de la estancia. Esta función se activa situando el interruptor en la posición invierno. Las aspas giran entonces en el sentido de las agujas del reloj, lo que produce que el ventilador absorba el aire frío del suelo hacia arriba, empujando al caliente, el cual desciende por las paredes. Todo ello sin crear ninguna sensación molesta de corriente de aire.

---

## HOW TO CHOOSE YOUR FAN / ELEGIR TU VENTILADOR

For rooms under 25m2 we recommend a diameter fan between 112 and 122cm. And for rooms under 40m2 we recommend fan diameter between 132 and 137cm. The maximum distance between fan and floor should be 2,4m, if distance is bigger the air produced will be lower. The minimum distance between ceiling and the fan's top should be about 30cm and the minimum distance between blades and the wall should be 50cm. The ambiance temperature should be 20-24° and each increase of decrease

Para habitaciones de hasta 25m2, se aconseja un diámetro de ventilador entre 112 a 122cm. Y para habitaciones de hasta 40m2 se aconseja un diámetro de ventilador entre 132 a 137cm. Para elegir la situación del ventilador, la distancia máxima hasta el suelo será de 2,40m, si existe más distancia el aire no llegará bien. La distancia mínima desde el techo hasta la parte superior del ventilador debe tener unos 30cm, y la distancia mínima desde el extremo exterior de la pala hasta la pared será de 50cm. La temperatura ambiente aconsejada es de 20° a 24°, y está demostrado que cada aumento o disminución de un grado supone 6% de los gastos de calefacción. Para ayudar a mantener este equilibrio térmico, todos nuestros ventiladores tienen la "función invierno", girando inversamente de forma que el aire caliente acumulado en el techo baja y se distribuye por toda la habitación.

# LINEAR COMBINATIONS COMBINACIONES LINEALES

Complete your project using linear bars in different sizes for our lighting fixtures.

Completa tus proyectos usando las regletas lineales en sus distintos tamaños en nuestras luminarias.

**G435-80**

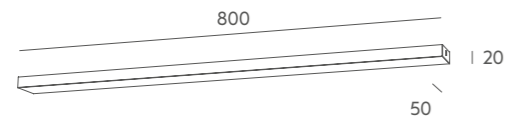

**G435-50**

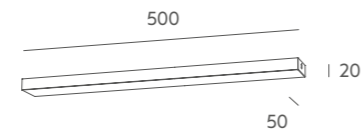

**G435-30**

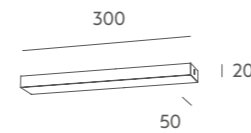

Metal Colour / Acabado Metal



BMT NMT

Example composition / Ejemplo composición

**G435-50 + Ref 6984 + Ref 6985**

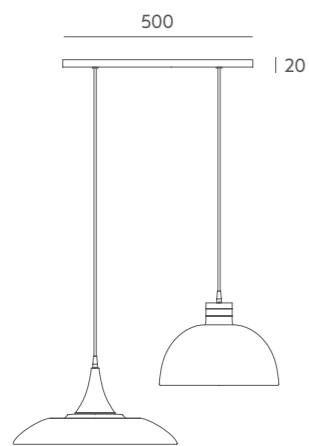

**G435-50 + Ref 6992 x 2 + Ref 6991 x 2**

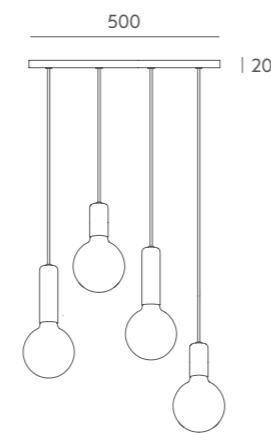

**G435-50 + Ref 6012 G x 2**

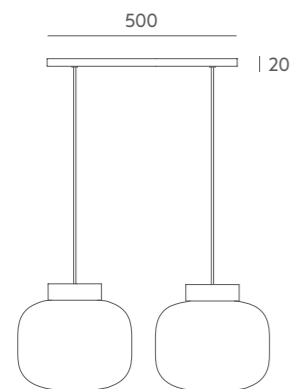

**G435-30 + Ref 6012 P + Ref 6012 G**

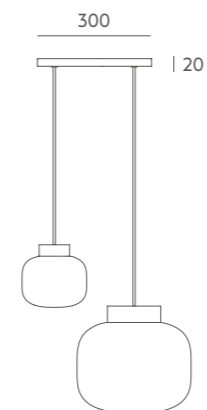

**G435-80 + Ref 6015-60 x 2**

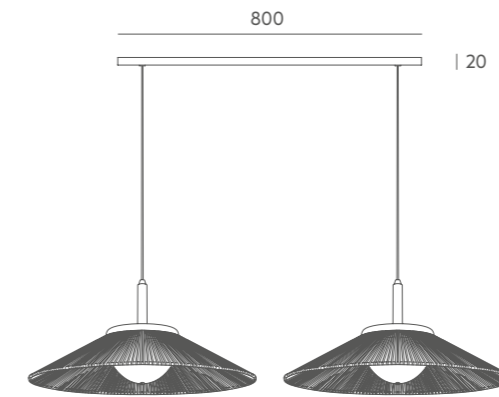

**G435-80 + Ref 6018 x 2 + Ref 6017**

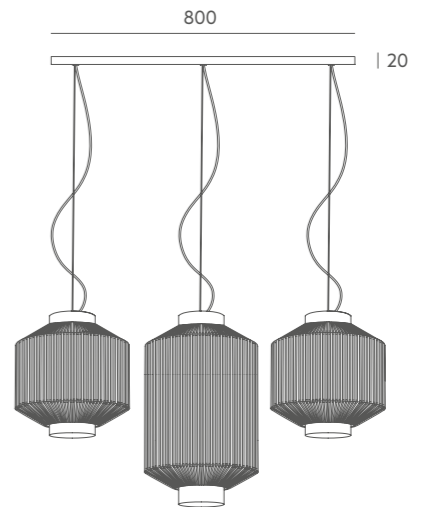

**G435-80 + Ref 6974 + Ref 6982 + Ref 6976 + Ref 6973**

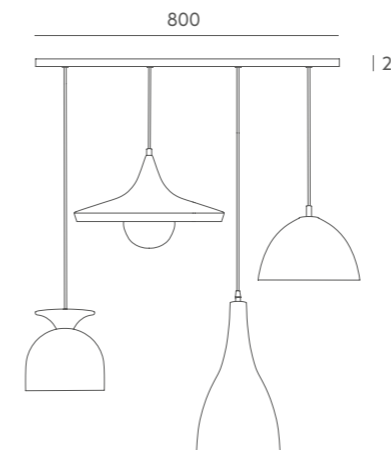

**G435-80 + Ref 6983 G x 2 + Ref 6983 P x 2**

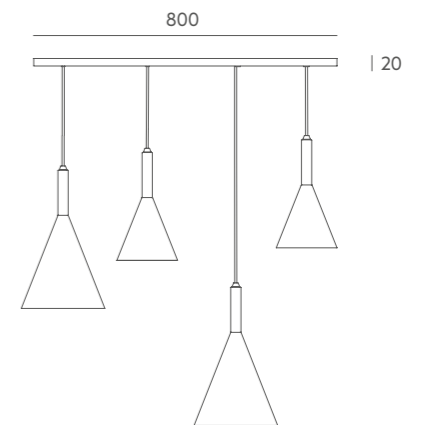

**G435-80 + Ref 6921-35 x 2 Pleated / Plisado**

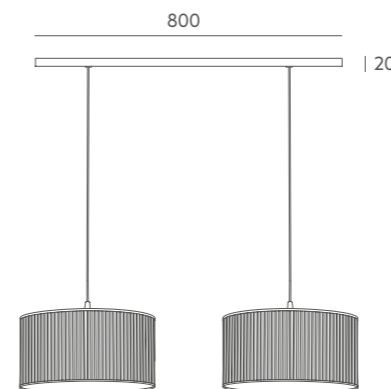

**G435-80 + Ref 6920-50 x 2 Cotton / Algodón**

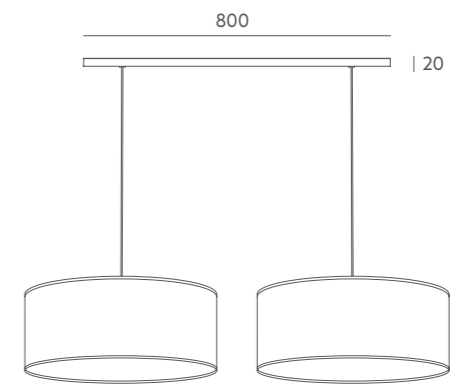

# ROUND COMBINATIONS COMBINACIONES CIRCULARES

Complete your projects using round plates in different sizes to personalize our lighting fixtures.

Completa tus proyectos con los platos circulares en sus distintos diámetros para personalizar nuestras luminarias.

G434-70

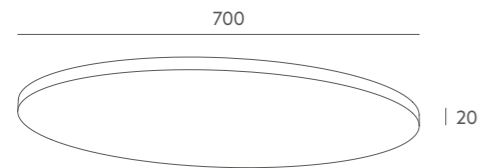

G434-45

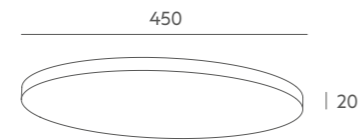

G434-30

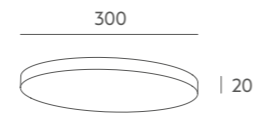

Metal Colour / Acabado Metal



BMT NMT

Example composition / Ejemplo composición

G434-70 + Ref 6013-1 x 3 + Ref 6013-2 x 2

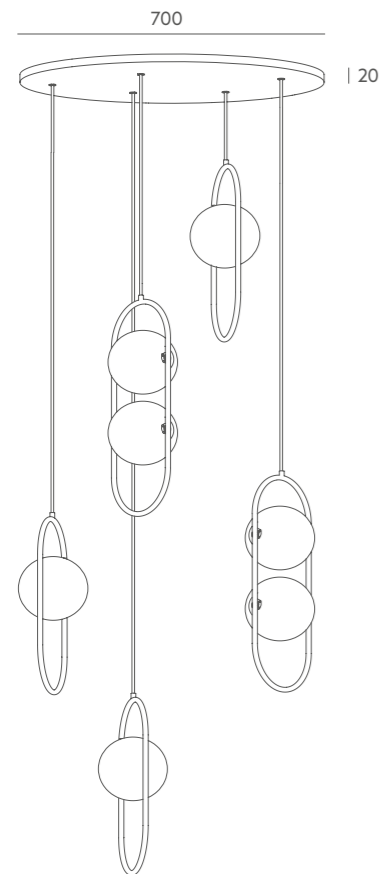

G434-70 + Ref 6015-40 x 3 + Ref 6015-60 x 2



G434-45 + Ref 6002 x 3 + Ref 6001 x 2

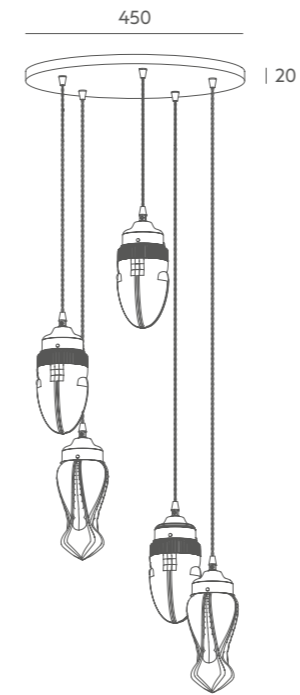

G434-45 + Ref 6984 x 2 + Ref 6985

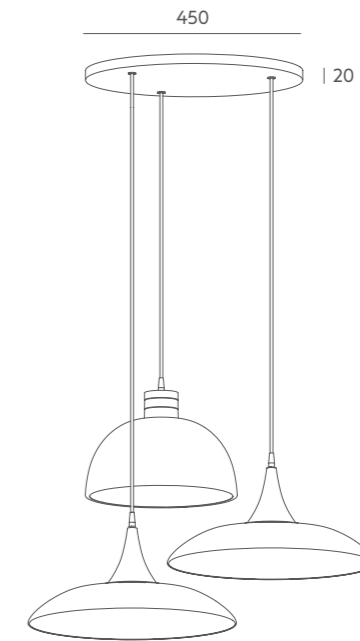

G434-30 + Ref 6983 P x 2 + Ref 6983 G

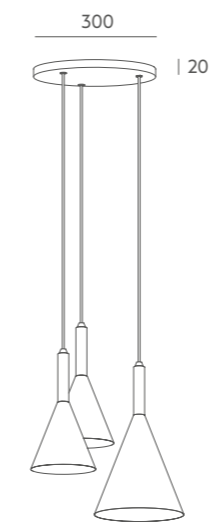

G434-30 + Ref 6013-1 + Ref 6013-2

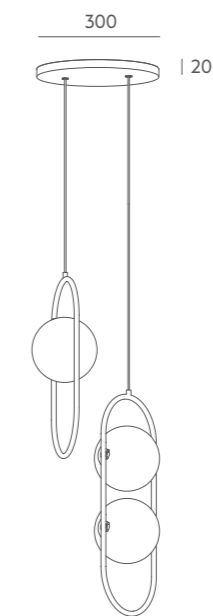

G434-30 + Ref 6992 x 2 + Ref 6991

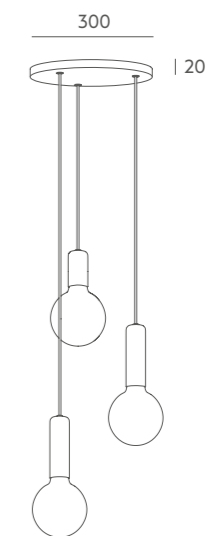



# BULBS BOMBILLAS

Complete your lighting fixtures with this bulb selection.

Completa tus luminarias con esta selección de bombillas.

Ref 03083 PL  
E27 6W LED (750 lm) **A+**  
2.700° K / 25.000h



Ref 03083 CO  
E27 6W LED (750 lm) **A+**  
2.700° K / 25.000h



Ref 03081  
E27 40W **A+**  
Decorative incandescent / 1.000h



Ref 03094-125  
E27 6W LED (800 lm) **A+**  
2.700° K / 25.000h



Ref 03082  
G9 4W LED (350 lm) **A+**  
3.000° K / 25.000h



Ref 03086  
E27 11W LED (1.100 lm) **A+**  
3.000° K / 25.000h



Ref 03084  
E27 7W LED (650 lm) **A+**  
3.000° K / 25.000h



Ref 03085  
E14 7W LED (650 lm) **A+**  
3.000° K / 25.000h



# SCROLLINGS DESPLAZAMIENTOS

These small pieces will give shape to your installation and allow you to run your cables exactly in the way you imagined.

Estas pequeñas piezas darán forma a tu instalación y te permitirán desplazar los cables de la forma que imagines.

Decentralizer, ceiling hook for textile electric cable.  
Descentralizador, gancho de techo para cable eléctrico textil con tope.

Ref 03036 NE



Ref 03036 BL



Decentralizer, ceiling or wall V hook for textile electric cable.  
Descentralizador, gancho en V de techo o pared para cable eléctrico textil.

Ref 03037 NE



Ref 03037 BL



Universal cablefitting to fix textile cable to the Wall.  
Prensaestopas universal para fijación a la pared para cable textil.

Ref 03038 NE



Ref 03038 BL



# GENERAL SPECIFICATIONS

## CARACTERÍSTICAS GENERALES

### COMMENTS

The products of the Massmi brand owned by Industrias Massmi S.L. are designed and manufactured to keep customers satisfied, so we inform them of:

- 1 Due to the quality of our finishes, we recommend using a soft dry polish cloth for cleaning, avoiding the use of special cleaning products that could damage the finish.
- 2 Do not use lamps of a higher power than indicated.
- 3 All models are patent protected.
- 4 Measurements in mm.
- 5 Standard cable length 1 m.
- 6 The lampshades included in this catalogue are our standard shades, made in Spain. Can be delivered as spare part. You can ask for changes of material for a minimum of 4 pieces.
- 7 Massmi will attend all the Customer claims within 7 days after the goods reception.
- 8 Massmi will not accept any claim concerning damages produced by the transport agency if the Customer does not inform the agency within a maximum of 24 hours after delivery.
- 9 Devolutions of material accepted by Massmi need to have the original packing. For claims concerning shades it is necessary to keep it in same plastic packaging, we won't accept any claim without it.

Industrias Massmi S.L. reserves the right to modify or discontinue, without previous notice, products in the catalog.

### OBSERVACIONES

Los productos de la marca Massmi propiedad de Industrias Massmi S.L. han sido diseñados y fabricados para satisfacer al máximo a nuestros clientes, por eso les informamos de:

- 1 Dada la calidad de nuestros acabados, aconsejamos efectuar la limpieza exclusivamente con una gamuza seca, evitando el uso de productos especiales que podrían dañar la superficie.
- 2 No deberán utilizarse bombillas de potencia superior a la indicada.
- 3 Modelos protegidos por el Registro de la Propiedad Industrial.
- 4 Medidas en mm.
- 5 Cable largo estándar 1 m.
- 6 Las pantallas que aparecen en catálogo son nuestras pantallas estándar todas ellas de fabricación nacional. Podrán ser suministradas sueltas. A partir de 4 unidades se pueden solicitar cambios de material (siempre que sea posible dicho cambio).
- 7 Massmi atenderá todas las reclamaciones efectuadas dentro de los 7 días hábiles posteriores a la recepción de la mercancía y con la hoja de gestión de los pedidos que enviamos junto al albarán debidamente cumplimentada.
- 8 Massmi no se hará cargo de roturas o deterioros producidos por la agencia de transporte si el cliente no lo ha comunicado a la agencia dentro de un plazo máximo de 24h desde la recepción de la mercancía.
- 9 Las devoluciones de material aceptadas por Massmi tendrán que venir siempre en su embalaje original. Para efectuar reclamaciones de pantallas será imprescindible que el artículo sea devuelto con la protección original (plástico retráctil), no se aceptarán aquellos que no lo lleven.

Industrias Massmi S.L. se reserva el derecho a modificar o anular, sin previo aviso, productos de este catálogo.

### SYMBOLS / SÍMBOLOS



Products manufactured according to the European safety and electromagnetic standards (EN 60598-1 and EN 60598-2-1)  
Productos fabricados acorde con las directrices de seguridad y emisiones electromagnéticas según la legislación europea aplicable (EN 60598-1 y EN 60598-2-1)



Product protected against the penetration of solid bodies equal or bigger than 12 mm and against the access with a finger. No protection to the water (standard NF C 20 010)  
Producto protegido contra la penetración de cuerpos sólidos de diámetro superior o igual a 12mm. No accesible con los dedos. Sin protección al agua (norma NF C 20 010)



Basic insulation with earth wire (products Class I)  
Aislamiento básico con toma de tierra (productos de Clase I)



Reinforced or double insulation, without earth wire (products Class II)  
Aislamiento reforzado o doble, sin toma de tierra (productos de Clase II)



Energy efficiency / Low consumption / -30%  
Eficiencia energética / Bajo consumo / -30%



Energy efficiency / Low consumption / 30%-42%  
Eficiencia energética / Bajo consumo / 30%-42%

# FINISHES ACABADOS

## ROPE COLOUR / ACABADO CUERDA

-  MA Brown rope / Cuerda Marron
-  MO Mustard rope / Cuerda mostaza
-  TE Terracotta rope / Cuerda terracota
-  VE Green rope / Cuerda verde

























## METAL PLATE FINISHES / ACABADOS BAÑO

-  CR Shiny copper / Cobre brillo
-  CR Chrome / Cromo
-  GR Graphite / Grafito
-  D Shiny gold / Dorado brillo
-  DM Gold matte / Dorado matte
-  LA Satin brass / Latón satinado
-  NI Nickel satin / Níquel satinado

## PAINTED FINISHES / ACABADOS PINTURA

-  AZ Blue / Azul
-  BE Beige / Beige
-  BMT Matte white / Blanco mate
-  D Gold paint / Pintura oro
-  GA Garnet / Granate
-  GR Grey / Gris
-  MO Mustard / Mostaza
-  NMT Matte Black / Negro mate
-  CO Copper paint / Pintura cobre
-  PE Pearl / Perla
-  TE Terracotta / Terracota
-  VE Green / Verde
-  BL-D Matte white (ins D) / Blanco mate (int D)
-  NE-D Matte black (ins D) / Negro mate (int D)
-  NMT-D Matte black with gold kneecup / Negro mate con rótula latonada
-  VE-D Matte green with gold kneecup / Verde mate con rótula latonada

## SHADE MATERIALS / PANTALLAS









-  AZ Blue cotton / Algodón Azul
-  BL White cotton / Algodón blanco
-  CR Beige / Algodón crema
-  GR Grey cotton / Algodón gris
-  NE Black cotton / Algodón negro
-  MA Brown cotton / Algodón Marrón
-  VE Green cotton / Algodón verde
-  BL-D White cotton (ins D) / Algodón blanco (int D)
-  CR-D Beige cotton (ins D) / Algodón Crema (int D)
-  D-CR Gold (ins CR) / Dorado (int CR)
-  NE-D Black cotton (ins D) / Algodón negro (int D)
-  BL Ash-tree white colored / Fresno tintado blanco
-  HA Natural beech / Haya natural
-  LI-BL White linen / Lino blanco
-  LI-MA Brown linen / Lino marron
-  RE Reed weaved / Rejilla
-  BL Ribbon of white silk / Cinta seda blanca
-  CR Ribbon of cream silk / Cinta seda crema
-  GR Ribbon of grey silk / Cinta seda gris
-  NE Ribbon of black silk / Cinta seda negra
-  VE Ribbon of green silk / Cinta seda verde
-  LA Lamitex / Lamitex (Min. 4uds)
-  PC Beige pleated / Plisado crema
-  PLI Pleated parchment / Pergamino plisado
-  PN Black pleated / Plisado negro

Any other finish not included in our sample finishes could be done for a minimum quantity, ask for the budget  
Cualquier acabado diferente al muestrario podría ser realizado con un mínimo de unidades y bajo presupuesto previo.





# FINISHES

## ACABADOS

### GLASS / CRISTAL

-  AM Amber glass / Cristal ambar
-  AZ Blue glass / Cristal azul
-  D Gold / Pan de oro
-  PL Silver / Pan de plata
-  MT Matte / Mate
-  TR Transparent / Transparente
-  OP Shine Opal / Opal brillo
-  OP-MT Opal matte / Opal mate

### WOOD / MADERA

-  HA Natural beech / Haya natural
-  HA-NE Black beech / Haya negra
-  RO Oak / Roble
-  RO-NE Black oak / Roble negro
-  BL Lacquered white / Blanco lacado

### METHACRYLATE / METACRILATO

-  OP Opale / Opal

### LEATHER / PIEL

-  MA Brown leather / Piel marrón



A brand of / Una marca de

**INDUSTRIAS MASSMI S.L.**

Avda. Villa de Madrid, 48  
Pol. Ind. Fuente del Jarro  
46988 Paterna, Valencia - España  
T. +34 961 321 416

massmi@massmi.com  
MASSMI.COM

Graphic design and Art Direction / Maquetación y dirección de arte  
Aranda Aloy Enblanc

Photography / Fotografía  
ángelsegurafoto<

Printed / Imprime  
La Imprenta Comunicación Gráfica

Massmi 2024

MI  
MASSMI.COM

MI  
MASSMI.COM

SINCE 1942